

# FC-7668PRO USER MANUAL

## ANTI-THEFT ALARM CONTROLLER

This manual is for reference only and will not be notified  
if there is any version update.

P/N: 23171102B09



# Wiring Diagram

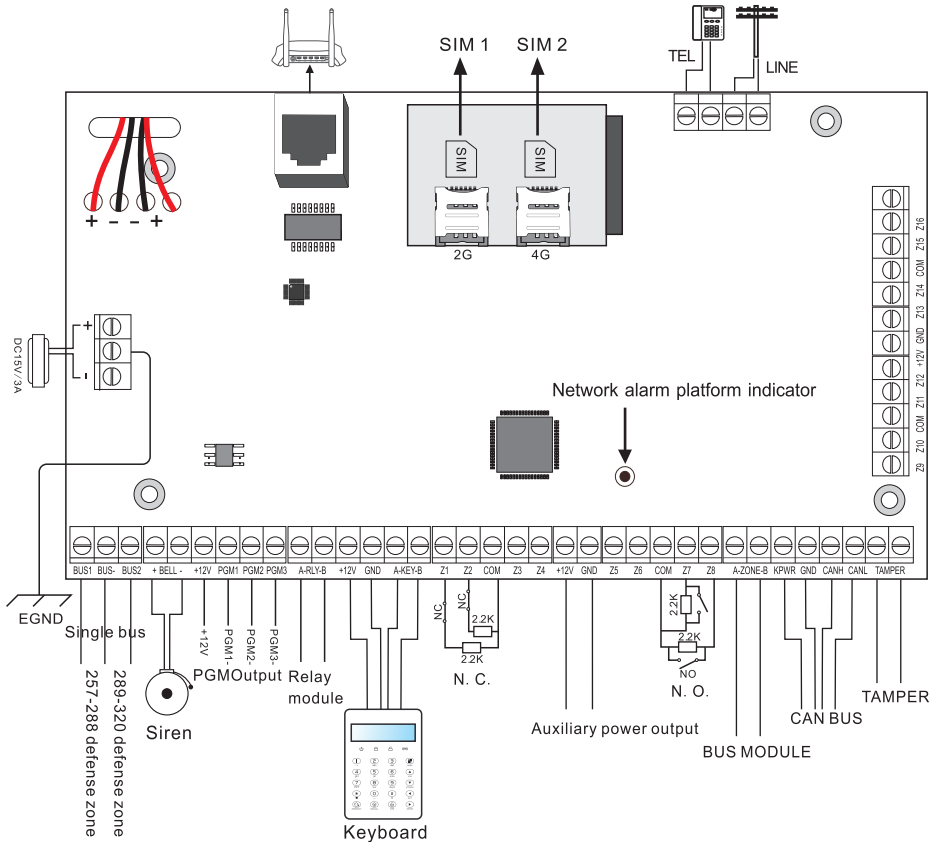

## Power supply

The power supply is DC15V/3A switching power supply

- ▲ Use 12VDC, 7Ah sealed lead-acid battery, and replace it every 3-5 years
- ▲ A standard system with a keyboard power consumption of 180mA can support 24 hours
- ▲ When using without siren, connect a 2.2K resistor to clear the siren fault
- ▲ The total power demand of keyboard, auxiliary power supply, siren, etc. does not exceed the maximum power of the host
- ▲ The maximum charging current of the battery is 350mA
- ▲ When using wired/bus defense zones, you need to set the defense zone attributes in the defense zone attribute settings.

**Note: If you need to use SIM card, please load the SIM card into the host card slot before powering on.**

# Wired Siren Wiring Instructions

When wiring with wired siren,  
please refer to the following connection method:

Figure 1:

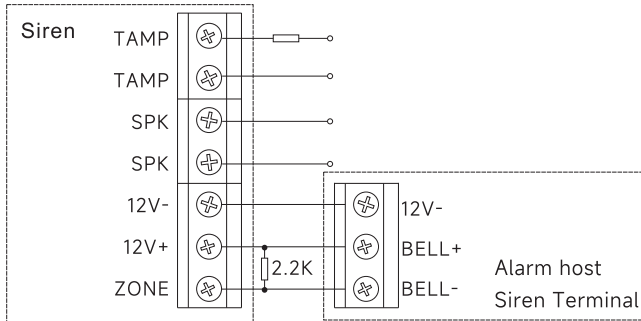

Low level alarm connection

When the input voltage of the ZONE terminal  
falls below 1V, an alarm will be triggered

Figure 2:

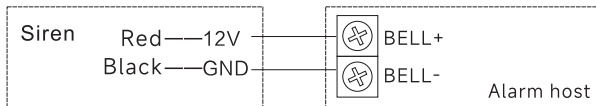

# Expansion Module Description

## Wiring instructions

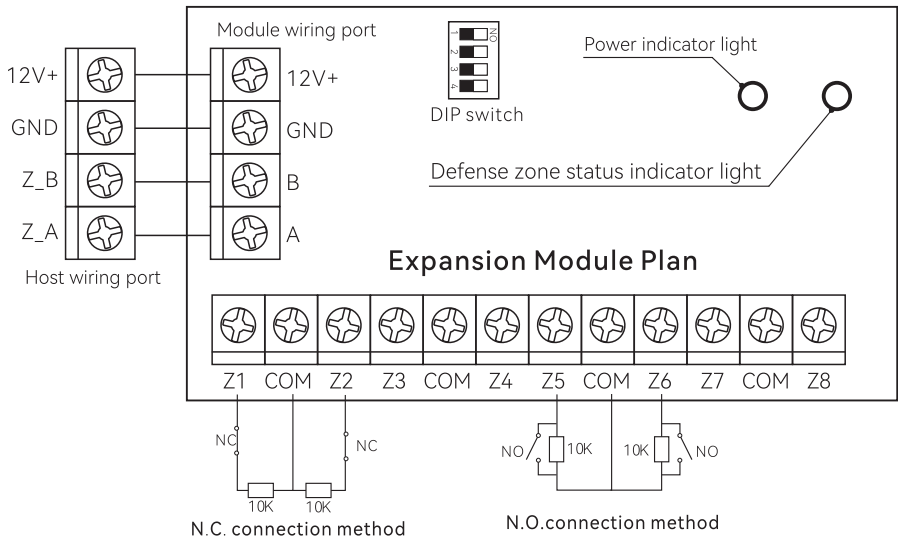

## Light

Power indicator: always on when power is on;

Zone status indicator: Zone is enabled and flashes slowly when normal  
When the zone is faulty, it always lights up.

## Dialing code description

It is valid when the switch is turned to OFF, please dial according to the table below.

NO.	DIP SW#	Zone#	NO.	DIP SW#	Zone#
1	1111	129~136	9	1110	193~200
2	0111	137~144	10	0110	201~208
3	1011	145~152	11	1010	209~216
4	0011	153~160	12	0010	217~224
5	1101	161~168	13	1100	225~232
6	0101	169~176	14	0100	233~240
7	1001	177~184	15	1000	241~248
8	0001	185~192	16	0000	249~256



---

---

# Content

Foreword	1
Features	2
Led instruction of network alarm platform	2
Insert SIM card	3
Remote phone control	3
Take alarm call from alarm panel	4
GSM SMS remote control	4
7602 dual zone expander module	5
keypad instructions	6
Wiring instructions	6
Keyboard address setting	6
Function button	7
Led lights	7
Common operation	8
Public zone	10
Duress password	11
Arm/disarm alarm panel	12
Alarm procedure	13
System maintenance	14
Programmable output	15
I. System setting	16
1. Set sys password	16
1.1 Set admin pwd	16
1.2 Set main user code	17
1.3 Set user code	17
1.4 User ability	17
2. Set system network	18
2.1 Set DHCP	18
2.2 Set IP	19
2.3 Set gateway	19
2.4 Set subnet mask	20
2.5 Set DNS	20
3. Set CMS	20
3.1 Phone ala center	20
3.1.1 Set CMS line 1	21
3.1.2 Set CMS line 2	21
3.1.3 Set account	21

---

---

---

3.1.4 Enter dial times	21
3.2 Network CMS	22
3.2.1 Set server IP	22
3.2.2 Set server port	22
3.2.3 Set CMS account	22
3.3 SIA platform	23
4. Set voice phone	23
4.1 Phone num.set	23
4.2 Phone dial set	24
4.3 Phone SMS set	24
4.4 Phone dial times	25
5. Set SYS options	25
5.1 System time	25
5.2 Entry delay	26
5.3 Exit delay	26
5.4 Bell time	26
5.5 Force arm	27
5.6 Emergency tone	27
5.7 AC power off delay	27
5.8 Door sensor check	28
5.9 WLS sensor loss	28
5.10 Voice prompt	28
6. Set wireless	29
6.1 Set remote	29
6.1.1 Enroll remote	29
6.1.2 Enter remote code	29
6.1.3 Delete remote	30
6.2 Set WLS detector	30
6.2.1 Enroll detector	31
6.2.2 Enter code	31
6.2.3 Delete detector	32
6.3 Set WLS siren	32
6.3.1 Enroll siren	32
6.3.2 Delete siren	33
6.4 RF switch	33
6.4.1 Enroll switch	34
6.4.2 Enter switch code	34
6.4.3 Delete switch	34
7. Set system zone	35

---



---

---

7.1	Set zone type	36
7.2	Set zone siren	37
7.3	Doorbell tone set	37
7.4	Keyboard zone	38
7.5	Bus relay	38
7.5.1	Relay enable	39
7.5.2	NC/NO	39
7.5.3	Output time	40
8.	Set system area	40
8.1	Password area	41
8.2	Keypad area	41
8.3	Remote area	42
8.4	Zone area	42
8.5	Voice phone area	43
8.6	Slect partition	43
9.	Set other	44
9.1	Wired zone	44
9.2	Relay	44
9.3	SIM card set	45
9.3.1	GSM default set	45
9.3.2	GPRS default set	46
9.3.3	SIM card 1 set	46
9.3.4	SIM card 2 set	46
9.4	Timing arm/disarm	47
9.5	Single bus device	47
9.5.1	Device status	48
9.5.2	Device info	48
9.5.3	Device opttion	48
9.5.4	Device restart	49
9.5.5	Restore to fact	49
9.6	Keypad fault disp	50
10.	Advanced set	51
II.	WEB setting	53
1.	Access to the host	53
2.	Basic management	54
2.1	System Kanban	54
2.2	System management	55
2.3	Wireless device	56
2.4	Single bus device	57

---

---

---

2.5 Smart control	57
2.6 Scene management	57
2.7 Other settings	59
2.7.1 Wired zone settings	59
2.7.2 Bypass group setting	60
2.7.3 Relay settings	60
2.7.4 Keyboard area settings	60
2.7.5 Keyboard fault display	61
2.8 System log	61
3. Network settings	62
3.1 TCP/IP settings	62
3.2 GPRS settings	63
3.3 Email settings	64
3.4 CMS platform	64
3.5 SIA platform	65
3.6 PSTN alarm platform settings	67
4. System options	67
4.1 Alarm parameter settings	67
4.2 Alert settings	69
4.3 Password settings	70
4.4 Voice call settings	71
4.5 Timing Arm/Disarm	73
5. System maintenance	74
5.1 System information	74
5.2 Time settings	74
5.3 System restart	75
5.4 System backup	76
5.5 System restore	76
5.6 System upgrade	77
5.7 Reset device	77
III. App use	78
1. Download and installation	78
2. Account registration	78
3. Add panel	79
Technical specifications	80
System maintenance	80
Product function limitation	81

---

## Foreword

Thank you for choosing the "FC" series products . Congratulations on your obtaining a set of reliable and multi-functional security products that have been tempered and passed a variety of certifications.

"FC-7668PRO" is an intelligent anti-theft alarm control panel that integrates anti-theft, fire prevention and gas leakage prevention, and is compatible with wired and wireless alarm methods. Remote operation through the Internet, mobile phone APP, CMS, etc. greatly facilitates the user's control of security information.

The "FC-7668PRO" also uses the most advanced international BUS zone coding technology and multi-digit random code hopping technology in terms of safety and reliability, which effectively avoids the interference and false alarms that are difficult to solve by the current similar systems. The "FC-7668PRO" supports the international SIA-2013 network GPRS in the alarm signal transmission mode, and also adopts the high-speed Contact ID format commonly used in the world, which makes the system more widely used and more compatible. This system can be widely used in family districts, villas, shops, enterprises and institutions and so on. In order to better use this product, please read this manual before use.

This manual has been checked in detail by the technicians, such as product upgrades and changes without notice.

### Warning:

- A.** Do not disassemble or modify, otherwise it may cause danger and cause damage to the machine.
- B.** Do not put other objects into the machine. Metal objects, water and flammable objects are all prone to short circuit or fire.
- C.** To avoid injury, do not drop the machine or subject it to strong impact.
- D.** Do not install the machine near a magnetic field, it may cause unstable operation.
- E.** Keep dry and clean. Do not set it in a place with oily smoke or steam, high temperature or a lot of dust.
- F.** Avoid high temperatures. Please do not install the unit near a heater or other high-temperature equipment, such as near a spotlight; also do not place it in a place that is easily exposed to direct sunlight, otherwise it may cause color fading. When cleaning, please wipe with a soft cloth. To remove dirt, you need to use detergent solution. Wipe after wringing out.
- G.** Never use chemicals such as gasoline or paint thinner, otherwise it may cause damage or paint peeling.

## Features

▲ It can be divided into 8 independent zones, with 64 wireless zones, 16 wired zones, 128 485 bus expansion zones, 48 keyboard expansion zones, 64 single bus zones, and 192 CAN bus zones, supporting a total of 512 channels  
Defense zone

▲ Defence zone definition: 1~16—wired zone; 17~80—wireless zone; 81~128—keyboard expansion zone; 129~256—bus expansion zone; 257~320—single bus zone; 321~512—CAN bus zone; 513~528—16 keyboard defense zones; 529~532—wireless siren; 533~548—16 remote controls; 550—platform; 552—key defense zone; 555—web client; 560~575—voice phone; 580~583 —Timed arming and disarming; 590—main user password; 591~622—32 user passwords

▲ The host has 1 webpage administrator account, 1 system administrator password, 1 main user account, 32 ordinary user accounts, and except for the system administrator password, all other accounts can log in to the webpage to access the host (ordinary users need to log in to the host) When the main user provides permissions);

▲ Support 8 remote controls, 4 two-way wireless siren, 16 keyboards, 32 radio switches;

▲ Support 2 network alarm receiving platforms and 2 telephone alarm receiving platforms, which can be set to backup mode and dual alarm mode;

▲ Support 16 personal phones to send voice and text messages;

▲ Support mobile phone APP remote control and alarm information push;

▲ 4 groups of timing arming and disarming time, you can assign any one or several partitions to be effective;

▲ Two SIM cards can be inserted, and the priority SIM card can be set.

## Led instruction of network alarm platform

Steady light-the network is normal;

Fast flashing-the network is faulty;

Flashing once per second-the network is connected to 1 platform;

Flashing twice per second-the network is connected to 2 platforms;

Flashing once in 3 seconds-GPRS is connected to 1 platform;

Flashing twice in 3 seconds-GPRS is connected to 2 platforms.

**Insert SIM card:** The telephone card is Micro SIM .

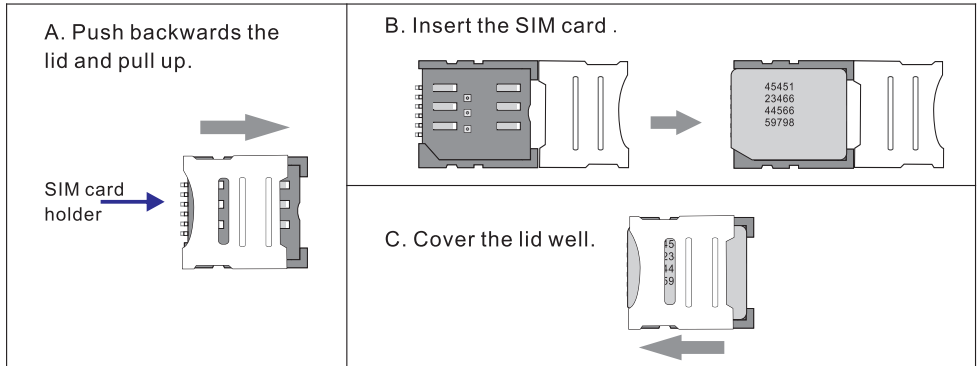

## Remote phone control

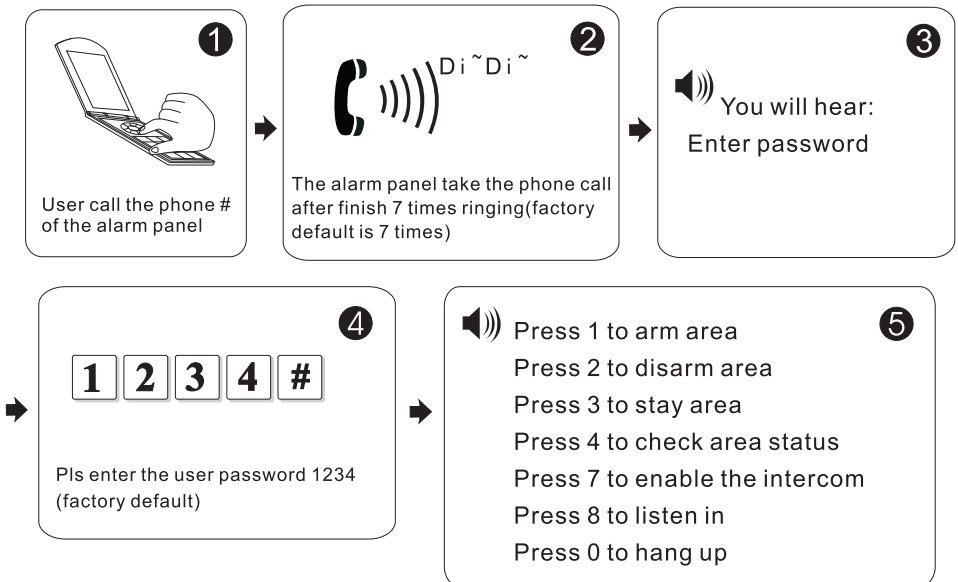

## Take alarm call from alarm panel

The alarm panel will call the user when alarm happens. see below diagram.



④ You will hear below voice guidance on the phone call.

Press 1 to cancel alarm	Press 6 to enable siren
Press 2 to inquiry alarm event	Press 7 to disable siren
Press 3 to arm area	Press 8 to live monitoring
Press 4 to disarm area	Press 9 to PGM control
Press 5 to stay area	Press 0 to hang up

## GSM SMS remote control

Arm command:

Enter the sms command on phone

Disarm command:

Enter the sms command on phone

Stay arm command:

Enter the sms command on phone

Note: X is the area #, from 0 to 8, 0 is all partitions. Default use password 1234(no space). The password is the main user password or user password. You will receive a reply SMS message if the panel accept and proceed your SMS command.

## 7602 Dual Zone Expansion Module

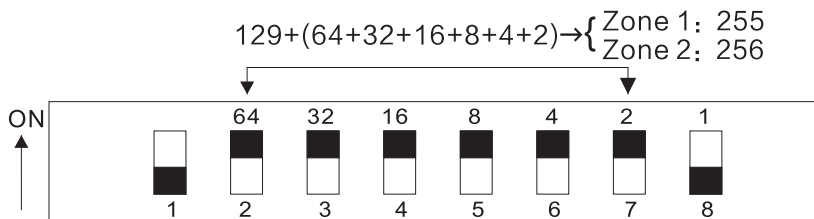

The black square "■" is the position of the dial code.

1. FC-7602 is a dial-up address code dual-zone module, and the resistance of the end of the line is 10K;
2. The address dialed by the expansion module is 129~256. If multiple expansion modules are connected, please note that the address cannot be repeated;
3. Wiring method: red wire (DC+), black wire (GND), yellow wire (RS487A), white wire (RS487B), green wire (NC1), black wire (GND), blue wire (NC2);
4. Operating voltage range: DC 8.5~24V;
5. The 1st bit of the DIP switch is the tamper detection switch, ON turns on the tamper detection, OFF means the tamper detection off; 2~8 are the address bits, ON is valid, OFF is invalid, the address calculation method is binary, For example, the address of defense zone 1 is 255: the dial code of position 2~7 needs to be dialed to the ON position (see the figure above), the address of zone 2 is 256, the set address of zone 1 is the dial code value + 129, and the address of zone 2 is dial Code value + 130.

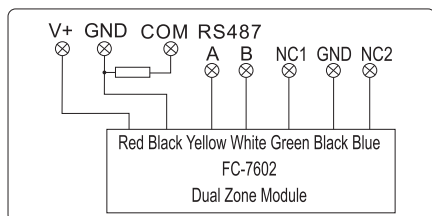

NO TAMPER

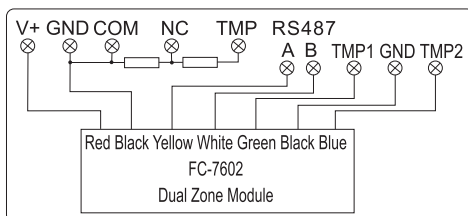

TAMPER

## Keypad instructions

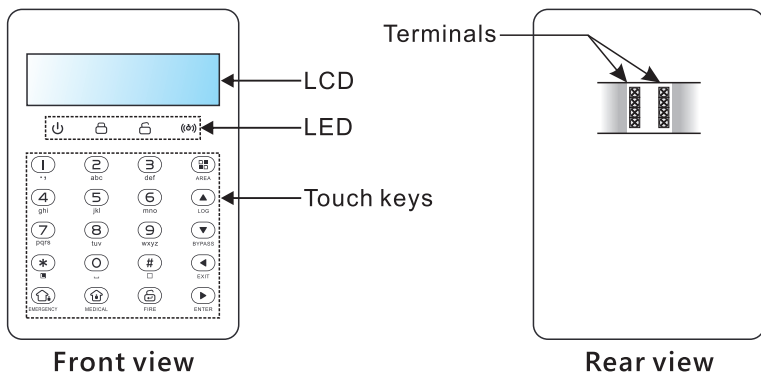

## Wiring instructions

Please follow the wiring diagram below to connect.

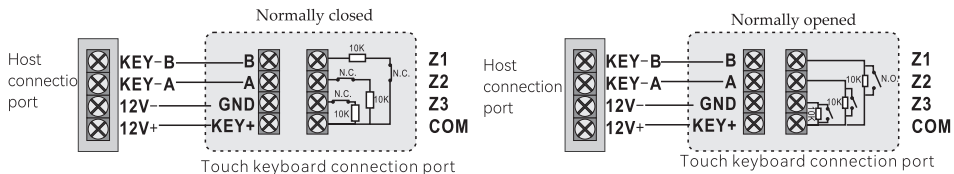





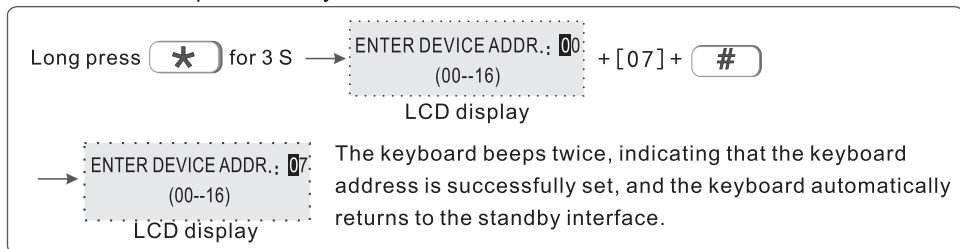



## Keyboard address setting

After accessing the new keyboard, the keyboard shows that no address has been set. Please press and hold **\*** for three seconds when disarmed and in the standby state to enter the keyboard address setting. Up to 8 keyboards can be added. For example: add keyboard as address 07.









## Function button

Icon	Meaning	Instructions
	Arm	The button can set arm multiple partitions at one time, and can also arm individual partitions separately. Press and hold for 3 seconds for emergency alarm
	Stay	The button can set multiple partitions to stay status, and can also set stay on a single partition. Press and hold for 3 seconds for medical care
	Disarm	The button can disarm for multiple zones ,or disarm the individual zones individually. Press and hold for 3 seconds for fire alarm
	Area	With Arm, Disarm, Stay to operate on a single Area.
	Up arrow	Select upward; long press for 3 seconds to increase the Volume; event record query
	Down arrow	Down select; long press for 3 seconds to decrease the Volume
	return key	Return to previous menu/exit menu
	Enter key	Enter options

## Led lights

Icon	Meaning	Instructions
	Power Indicator	On - normal power supply; Flash - AC power failure; Slow flash - battery failure;
	Arming indicator	On - all partitions in the management area; Flash - partition alarm; Slow flashing - Partial arming and disarming of managed zones
	Disarm indicator	On - all administrative divisions are disarmed; Flash - The zone of the managed zone is faulty. Slow Flash - Partition Zones Managed By Bypass
	Fault indicator	On - configuration parameter check error; Flash - platform connection and communication failure; Slow flash - network, GSM, PSTN failures; Off - No failure

Support 8 keypad. Pls scan and add keypad after repower the alarm panel. The keypad will not work if add without repower the alarm panel, in this case, you can re-scan to add the keypad on a keypad which already work by the command admin PW[012345]\*9#. Each keypad is with a different address. The first time connect the keypad, it will display fault event. Like battery problem, network problem etc.. , you can choose the event to display on WEB MENU.

## COMMON OPERATION

Default admin password is 012345, main user password is 1234. If you change it, please refer to the change.

**Enter project settings:** [012345]+ \* +[0]+ #

**Device restart:** [012345]+ \* +[1]+ #

**One-key arm:** Press (Home) / (Home), or press (Keypad) to press the keypad number to cancel the partition number X+ (Home) / (Home) to be disarmed. This function can only be used by opening the "Quick Arming" button in the "System Options" - "Alarm Parameters" in the settings of the host web page

### Section cloth evacuation

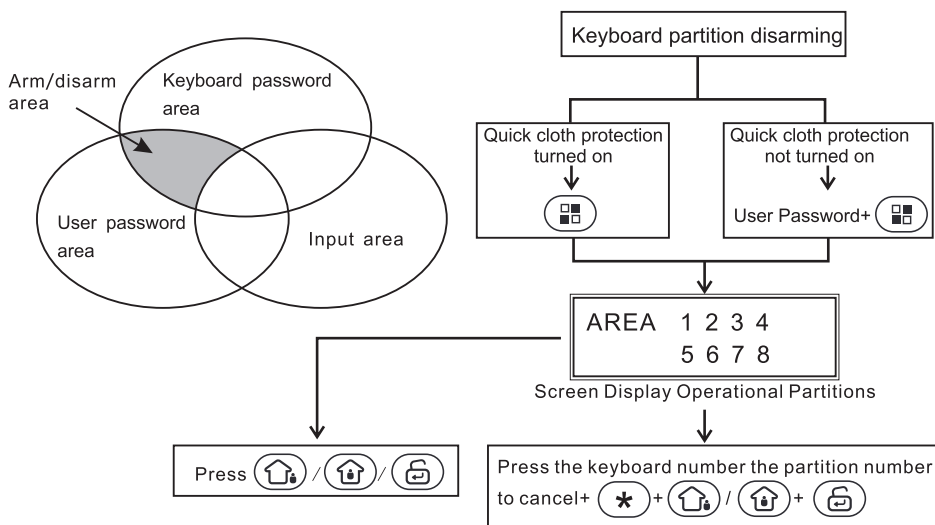

① Operational disarming area: the cross-section of the keyboard section and the user password (see page 41 ), and the uncrossed section is not displayed.









②Enter the partition arming: user password + , the user can first enter the web page to open the “quick arming” option, then you can directly enter the partition arming and disarming without entering the password. Please refer to the flowchart above for operation.



**Event logs:** Press  in the standby mode to view the event log, Up to 800 event records can be stored cyclically.



**Enter the bypass zone:** [1234]+  The keypad will display the bypassed zone when the zone is bypassed. Only the defense zone belonging to the password management partition can be bypassed. Only one keypad is allowed to enter the bypass setting at the same time. When one keypad is in the bypass setting state, an error will be prompted when other keypads try to enter the bypass setting. When a high-privilege request is made, if you enter the system settings, you will exit the bypass settings.



**Set/Cancel Bypass Group:** Master User Password +  +  + Bypass Group Number + , this setting is valid when two or more zones have formed a bypass group and the keypad and the zone of the bypass group belong to the same partition. The keypad will display the bypassed zone after the route, and the bypass group can be canceled by setting it again.



**System version display and device scan:** [012345] +  + [9] +  or press  + [1] +  to display the system version and rescan the keyboard port for new devices added.



**Web version display:**  + [2] +  to view the web version.



**Voice version display:**  + [3] +  to view the voice version.

**Keyboard key tone adjustment:** In standby mode, long press  / , and the keyboard emits a “Di Di” sound to increase/decrease a volume.

**Keyboard control relay:** [1234]+  + [7] + , the relay can be set to be normally open and normally closed.

**Keypad control bus module relay:** [1234]+  + [8] + , the bus module relay can be set to be normally open and normally closed.

**Forgot password:** 1 minute after the system is powered on, the defense zone will not alarm. Wait for the detector to initialize. Enter [000000]+  + [0] +  on the keyboard, or log in with the password “000000” on the web page to repair the user’s forgotten password.

**View automatic APN:** Press  + [4] +  to view card 1's automatic APN;

Press **\***+[5]+**#** to view the automatic APN of card 2.

**Note:** Area 1 is the main area. When area 1 is disarmed, the device can enter the setting state. Only when the keyboard has the authority to manage area1 can enter the system setting.

## Recording operation

**Recording:** [012345]+**\***+8+**#** Enter the recording control interface, press **#** to start the sound, press **\*** to stop the recording, press **◀** to exit the recording interface, it will automatically exit if there is no operation within 10 seconds.

**Recording playback:** When the voice call is answered, the recording is automatically played, and then the operation prompt tone is played.



## Public zone

When a zone belongs to multiple areas, this kind of zone is called a public zone, which is mainly used in shared passages and other places. The public zone will only alarm when the zone where it is located has alarm conditions, and when it is a delayed zone, If any area it belongs to cancels the alarm, the other areas it belongs to will also cancel the alarm; and if the zone alarms, all the areas it belongs to will alarm.

(1) The public zone will only alarm when all the areas it belongs to have its alarm conditions.

(2) Based on the reason (1), it is not recommended to set the public zone as an internal zone. It is better to set it as a delayed zone. When set to a delayed zone, the exit delay will only expire after the last operation arming zone exits and the public zone for unrecovered areas alarms, the last operator will handle the failure without affecting other area users. When the entry delay is triggered, all areas where it is located will be in the entry delay alarm. Before the delay ends, If any zone where the system is located is disarmed, the zone that is in the entry delay alarm caused by the public zone will cancel the delay alarm. Otherwise, when the delay is over, all zones where the public zone is located will alarm.

## Duress password

Duress Password: User Password/Admin Password + [0] +  /  / 

When you enter the duress password, you will trigger an duress alarm. If enter duress password When the system is under arm status, keypad will display system is disarmed, stop siren but send alarm info and alarm call.  
(pls set the CMS phone # and follow me phone #)

Example, A arm the system, B enter the area and trigger alarm, B threaten A disarm the system. A enter the duress password. The alarm panel will show disarm status but will send alarm info can call.

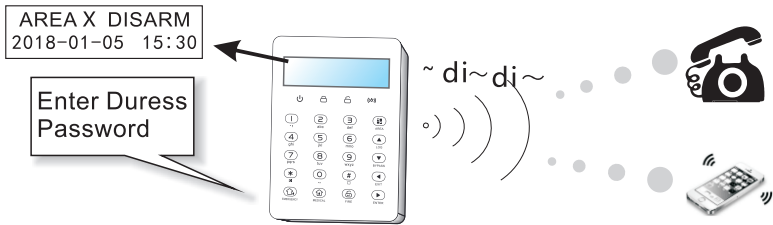

## Arm/disarm alarm panel

☆ Arm

~Di~Di~

AREA X ARM  
2018-03-25 15:30

Corresponding user password + or press disarm button remote control.

☆ Disarm

~Di~Di~

AREA X DISARM  
2018-03-25 15:30

Corresponding user password + or by pressing the disarm button of the corresponding remote control.

☆ Panic alarm

~Di~Di~

AREA X ALARM  
2018-03-25 15:30

Press and hold for or press the "emergency" button on the remote control for emergency help. Press and hold for to achieve "fire alarm".

☆ Stay

~Di~Di~

AREA X STAY  
2018-03-25 15:30

Corresponding user password + or press the home security button of the corresponding remote control.

The codes of arm/disarm via different ways:

Arm/disarm via remote controls: 1-8 remotes ---# 533-548

Arm/disarm via keypad zone, 16 keypad zones --- #513-528

Arm/disarm via Master user password : #590

Arm/disarm via user passwords: 1-32 user passwords ---# 591-622

Arm/disarm via voice call: 1- 16 voice call ---#560-575

Arm/disarm via CMS/APP: #550

Arm/disarm via auto timer: 4 timed zones --- #580-583

Arm/disarm via key zone: # 552

Arm/disarm via WEB page: #555

## Alarm procedure

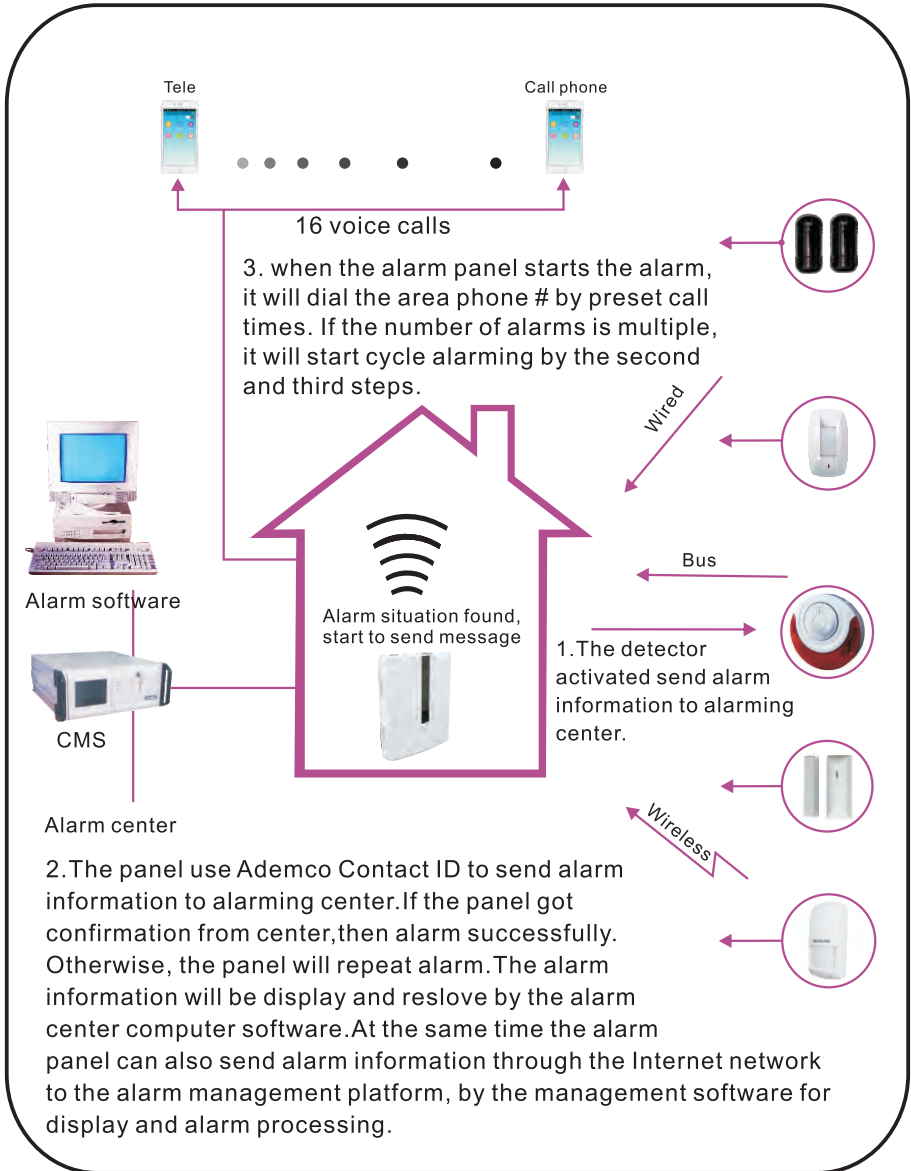

## System maintance

Pls make the below test before installation.

**Communication test:** main user password+\*1#;

**battery test:** main user password+\*2#.

**Siren test:** main user password+\*3#

**Walk test:** main user password+\*4# (disarm all area before start walk test)

1) **Communication test:** test the communication between alarm panel and CMS.

Main user password+  +[1]+  → CMS will receive timing test report message

2) **Battery test**

Main user password+  +[2]+  → 5 mins after CMS will receive battery status message



You can not start the alarm panel with only battery connect. But trigger the battery by AC power first. One battery test take about 4 mins, so, it will take at least 5 hours to report battery recover. When AC power is normal, battery test proceed every 24 hours. If battery disconnect, it will test battery every 10 mins. When battery voltage is low, it will test battery every 60mins. When AC power trouble, it will test battery every one minute.

3) **Siren test:** test the communication between siren and alarm panel

Main user password+  +[3]+  → trigger siren → siren sound

4) **Walk test**

example: walk test at zone 8

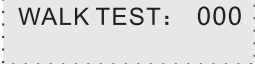
[1234]+  +[4]+  →  → trigger zone 8

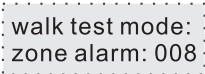
→ 

press  back to standby interface



### 5) Wireless switch management

The wireless switch can realize the alarm linkage output with the corresponding defense zone, and 32 wireless switches can be set.

Main user password+ **\*** +[5]+ **#** → Enter wireless switch management

## Programmable output

According to the set state parameters, when a specified event or state occurs, the programming output port voltage changes from 0V to 12V. 3 PGM output ports can be set. Set the trigger event on the web , as follows:

Burglary Recovery Panic	Area Alarm, Area Fault, Area Bypass, System Arm, System Disarm, System Stay, Cancel Alarm, Fault Recovery, Bypass Recovery, Failed to arm the system
Zone Event	Delay 1 alarm, Delay 2 alarm, Perimeter alarm, Internal alarm, Emergency alarm, 24 hours alarm, Fire alarm, Flooding alarm, Emergency, Dismantle alarm, Wireless device battery failure, Wireless device battery recovery, Lost wireless device, Zone bypass, Zone bypass recovery, Zone loop failure, Zone loop recovery, Delayed alarm recovery, Perimeter alarm recovery, Internal alarm recovery, Emergency alarm recovery, 24 hours alarm recovery, Fire alarm recovery, Emergency recovery, Dismantling alarm recovery, Wireless device loss recovery, Flooding recovery
System Event	Low system battery, System AC power failure, System AC power recovery, System programming changes, Communication test, System battery recovery, System communication failure, Zone bypass recovery, Alarm failure, Alarm recovery, Hold the alarm, Telephone line failure, Telephone line restoration, Module removal, Wrong password, Dismantle alarm, Tamper alarm recovery, Emergency alarm, Emergency alarm recovery, Emergency, Emergency recovery, Fire alarm, Fire alarm recovery, Network fault, Network Recovery, GSM faulty, GSM normal, CMS connection faulty, CMS connection normal, SIA connection faulty, SIA connection normal, System programming entry, System programming exit, System battery loss, System battery loss recovery, System battery failure, System battery failure recovery

Press the main user password+[\*6#] or open or close the programming output port by voice call. (Default is off)

Example: set PGM to Open.

Main user password+ **\*** +[6]+ **#** → Input PGM NO.: 1 (1--4)

+ **#** → PGM operation: 1 1>Open 2>Close +[1]+ **#**

# I. System setting

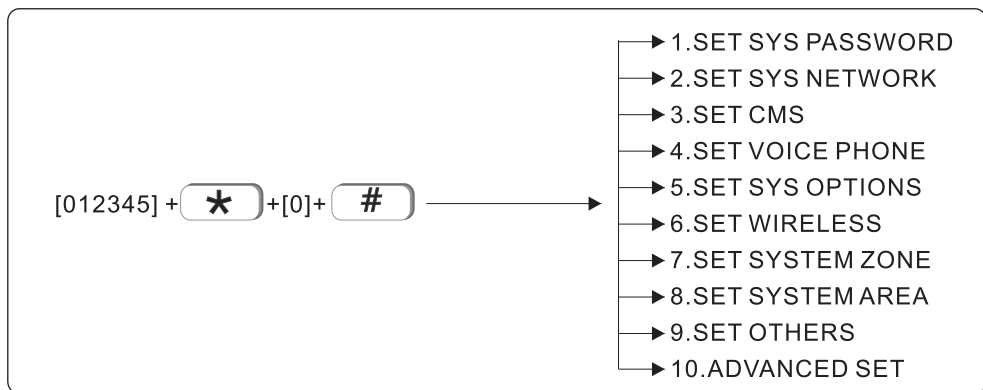

Note: only in disarm status, user can do system setting.

## 1.Set sys password

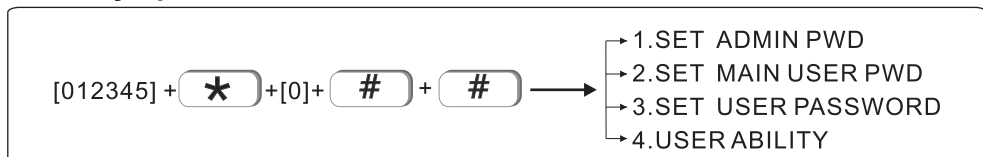

The central panel has one admin password, one main user password, 32 user password and Web login password. password can control one or more system area.

The password's right on keypad is decided by the system area the password can control and the system area the keypad can control.  
For example:

If user sets password No. 6 can control area 1, 2, 3, the keypad No. 5 can control area 3,4. Then the user can only control area 3 on keypad No. 5 via password No. 6

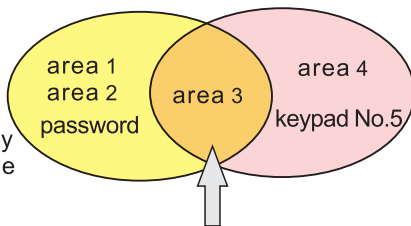

password No.6 can only control area 3

### 1.1 Set admin password

Admin password has the highest authority. E.g, set admin password as 555555.



+ ▲ + [555555] + #  
Press 6 times to delete the old password

The keypad will beep twice to confirm the password has been changed.



Tips: if forget admin password or web login password, please follow: Power off the central panel, and power on again, within 60s, enter 000000 as password to operate and set new password.

## 1.2 Set main user password

Please refer to user setting I

## 1.3 Set user password

User password is 4~6 digits. E.g Set user password no. 03 as 0000

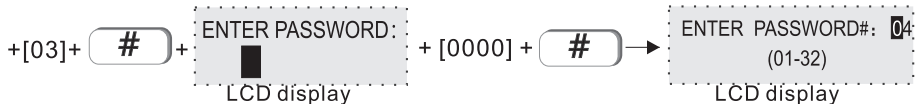
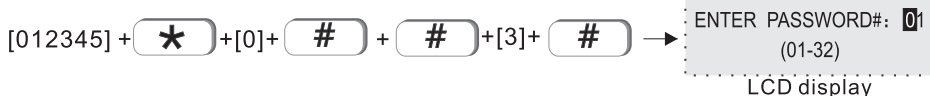

The keypad will beep twice to confirm the password has been changed. After this, the keypad will enter to set next password no. , press



## 1.4 USER ABILITY

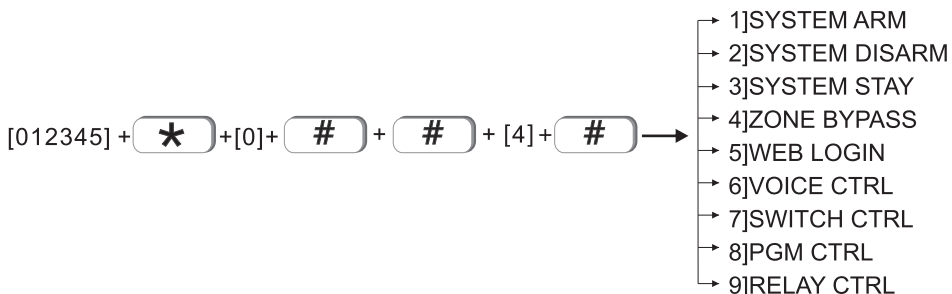

Set the user password authority with serial number from 1 to 32. After entering the authority setting, select the user serial number to "disable" or "enable" this authority. By default, web page control, electrical switch control, PGM control, and relay control are disabled, and other permissions are enabled. Such as: open the web page control permission of user 02.

[012345] + \* + [0] + # + # + [4] + # + [5] + #

→ ENTER PASSWORD#: 01: (01 -- 32) LCD display + [02] + # → WEB LOGIN: 1>DISABLE 2>ENABLE 1 LCD display + [2] + #

The keyboard makes two beeps, indicating that the permission modification is successful. After the setting is completed, the keyboard will automatically enter The next sequence number is set.

Press ← + ← + ← + # return to the standby interface.

## 2.Set system network

[012345] + \* + [0] + # + [2] + # →

- 1] SET DHCP
- 2] SET IP
- 3] SET GATEWAY
- 4] SET SUBNET MASK
- 5] SET DNS

### 2.1 Set DHCP (Default disable)

User can choose to enable or disable DHCP function.Eg. Enable DHCP function

[012345] + \* + [0] + # + [2] + # + # → DHCP: 1>DISABLE 2>ENABLE 1 LCD display

+ [2] + #

The keypad will beep twice to confirm it has been changed,the keypad will return to previous setting Press ← + ← + # back to standby interface.

## 2.2 Set IP



Factory default IP: 192.168.1.200

*Tips: If DHCP is enabled, then it is not able to set IP here.*

E.g. Set IP as "192.168.1.81", we need to enter "192168001081" in the keypad. User need to add "0" to make 3 digits if not enough. After set, please power off the central panel and restart to make the IP effective.





[012345] +  + [0] +  + [2] +  + [2] +  →   
LCD display

+ [192168002081] + 

The keypad will beep twice to confirm it has been changed, the keypad will return to previous setting. Press  +  +  back to standby interface.

## 2.3 Set gateway

E.g. Set gateway as 192.168.2.1

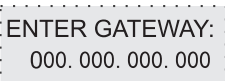
[012345] +  + [0] +  + [2] +  + [3] +  →   
LCD display

+ [192168002001] + 

The keypad will beep twice to confirm it has been changed, the keypad will return to previous setting. Press  +  +  back to standby interface.

## 2.4 Set subnet mask

E.g. Set subnet mask as 255.255.255.0



The keypad will beep twice to confirm it has been changed, the keypad will return to previous setting. Press ◀ + ◀ + # back to standby interface.

## 2.5 Set DNS

E.g. Set DNS as 202.96.128.85



The keypad will beep twice to confirm it has been changed, the keypad will return to previous setting. Press ◀ + ◀ + # back to standby interface.

## 3. Set CMS

CMS means central monitoring service, which is usually provided by security company with extra service cost.



### 3.1 Phone ala center



### 3.1.1 Set CMS line 1

When alarm is triggered, the central panel will dial CMS telephone No to inform the central monitor server. It can support to set 18 digits maximum.  
E.g. Set Set CMS line as 800012345

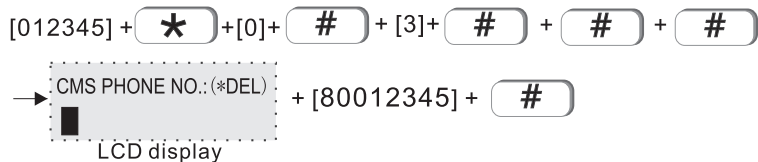

The keypad will beep twice to confirm it has been set, the keypad will return to previous setting. Press [Left] + [Left] + [Left] + [#] back to stand by interface.

### 3.1.2 Set CMS line 2

Please refer to 3.1.1

### 3.1.3 Set account

CMS platform can control many device at the same time. User no. Means the no. of this device in CMS platform .E.g. Set user no as 0001

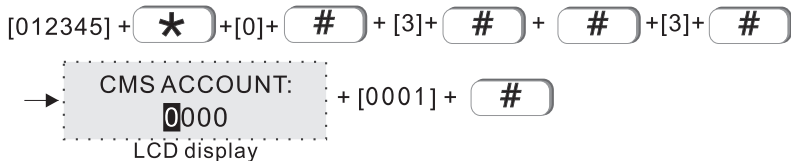

The keypad will beep twice to confirm it has been set, the keypad will return to previous setting. Press [Left] + [Left] + [Left] + [#] back to stand by interface.

### 3.1.4 Enter dial times (01-10)

When alarm happens, the device will dial the CMS telephone no.1 and no. 2 at the same time, the dial times in factory default is 5 times. if the call is still not answered after 5 times, it will stop to dial out.E.g. Set dial times as 8times.

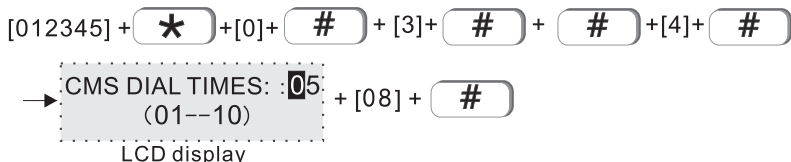

The keypad will beep twice to confirm it has been set, the keypad will return to previous setting. Press [Left] + [Left] + [Left] + [#] back to standby interface.

### 3.2 CMS platform

[012345] + **\*** + [0] + **#** + [3] + **#** + [2] + **#**

- 1>SET SERVER IP
- 2>SET SERVER PORT
- 3>SET CMS ACCOUNT
- 4>SET CMS PASSWORD

#### 3.2.1 Set server IP

Set CMS IP as 014.152.090.065

[012345] + **\*** + [0] + **#** + [3] + **#** + [2] + **#** + **#**

→ **SERVER IP:**  
**000.000.000.000** + [014152090065] + **#**  
 LCD display

The keypad will beep twice to confirm it has been set, the keypad will return to previous setting. Press **←** + **←** + **←** + **#** back to standby interface.

#### 3.2.2 Set server port

Factory default port: 7974

E.g. Set server port as 6598

[012345] + **\*** + [0] + **#** + [3] + **#** + [2] + **#** + [2] + **#**

→ **SERVER PORT:** **07974**  
 (00001--65535) + [06598] + **#**  
 LCD display

The keypad will beep twice to confirm it has been set, the keypad will return to previous setting. Press **←** + **←** + **←** + **#** back to standby interface.

#### 3.2.3 Set CMS account

CMS register ID and password are provided by the CMS operator. User can search the CMS register ID and password as below:



[012345] + \* + [0] + # + [3] + # + [2] + # + [3] + #

LCD will show the CMS register ID and password.

Press ◀ + ◀ + ◀ + # back to standby interface.

The query CMS password is the same as the registration ID.

### 3.3 SIA platform

For the setting of SIA platform, please refer to the setting method of CMS .

## 4.Set voice phone

[012345] + \* + [0] + # + [4] + #

- 1]PHONE NUM.SET
- 2]PHONE DIAL SET
- 3]PHONE SMS SET
- 4]PHONE DIAL TIMES

### 4.1 Phone num.set

16 voice phone numbers can be set for the phone number dialed by the host when an alarm occurs, and each voice phone number can be set to a maximum of 18 digits. For example: Set the voice phone number 2 to 88776655.

[012345] + \* + [0] + # + [4] + # + #

→ VOICE PHONE #: 01 (01-16) LCD display + [02] + # → VOICE PHONE NO.: \*DEL 00000000000 LCD display

+ [88776655] + # → VOICE PHONE #: 03 (01-16) LCD display

The keypad will beep twice to confirm it has been set, the keypad will return to previous setting. Press ◀ + ◀ + ◀ + # back to standby interface.

### 4.2 Phone dial set

Whether the phone number dialed by the host when an alarm occurs, the default is enabled.

For example: Voice phone number 2 is disable.

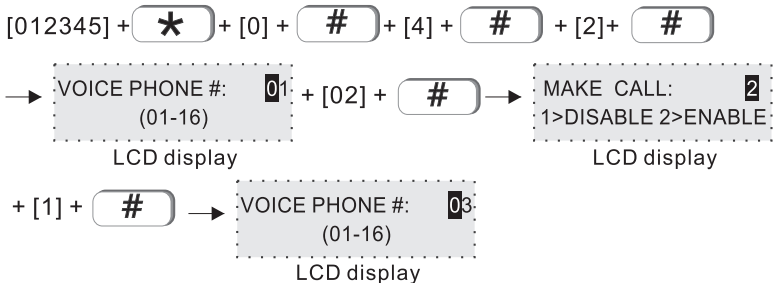

The keypad will beep twice to confirm it has been set, the keypad will return to previous setting. Press ◀ + ◀ + ◀ + # back to standby interface.

### 4.3 Phone SMS set

Whether the host will send alarm information to this phone number when an alarm occurs, the default is enabled.

Example: Voice phone number 6 is DISABLE.

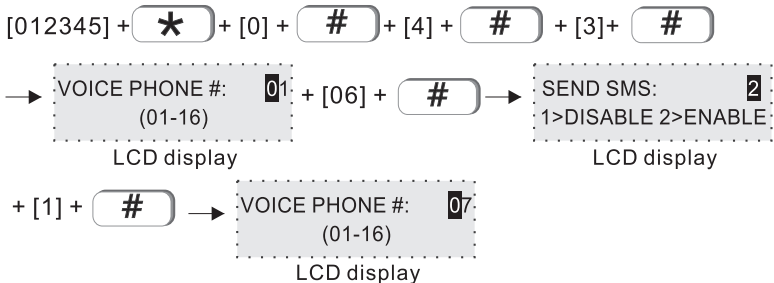

The keypad will beep twice to confirm it has been set, the keypad will return to previous setting. Press ◀ + ◀ + ◀ + # back to standby interface.

#### 4.4 Phone dial times (default is 5 times)

The number of times the host makes voice calls when the alarm is not cleared.  
For example: Set the number of voice calls to 6 times.

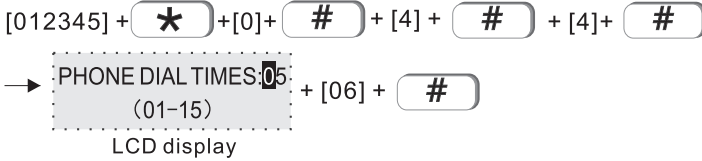

The keypad will beep twice to confirm it has been set, the keypad will return to previous setting. Press **◀** + **◀** + **#** back to standby interface.

### 5. Set sys options

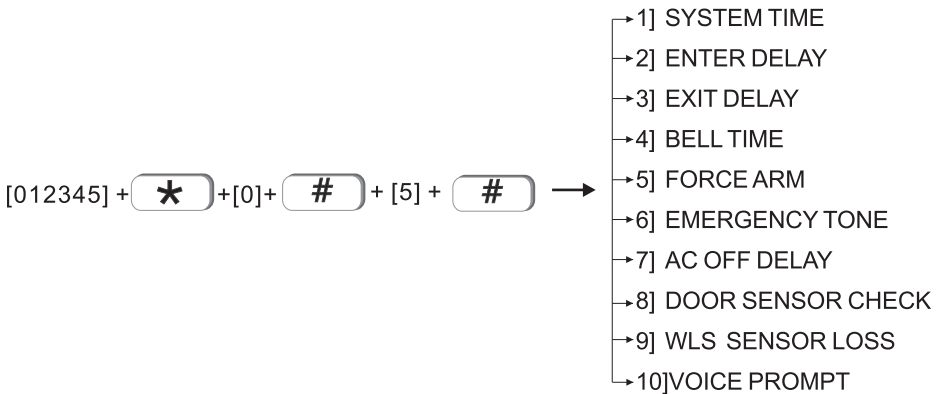

#### 5.1 System time

E.g. Set system time as Oct, 1st, 2017 23:59:59

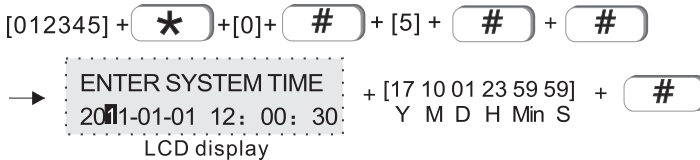

The keypad will beep twice to confirm it has been set, the keypad will return to previous setting. Press **◀** + **◀** + **#** back to standby interface.

### 5.2 Enter delay

After triggering the delay zone, the default time of the alarm delay 1 of the host is 30 seconds, and the default time of delay 2 is 45 seconds (the entry delay time is 1~255 seconds). For example: set the entry delay time as 20 seconds.

[012345] + **\*** + [0] + **#** + [5] + **#** + [2] + **#**

→ ENTER DELAY 1: **015**  
(001--255)S + [020] + **#**

LCD display

The keypad will beep twice to confirm it has been set, the keypad will return to previous setting. Press **←** + **←** + **#** back to standby interface.

### 5.3 Exit delay

The default time from when the user arm the host until the host enters the armed state is 10 seconds. (Exit delay time is 1~255 seconds) .

For example: Set the exit delay time to 20 seconds.

[012345] + **\*** + [0] + **#** + [5] + **#** + [3] + **#**

→ EXIT DELAY: **030**  
(001--255)S + [020] + **#**

LCD display

The keypad will beep twice to confirm it has been set, the keypad will return to previous setting. Press **←** + **←** + **#** back to standby interface.

### 5.4 Bell time

After the host alarms, the siren ringing time defaults to 5 minutes.

For example: Set the siren time to 10 minutes.

[012345] + **\*** + [0] + **#** + [5] + **#** + [4] + **#**

→ ALARM BELL TIME: **05**  
(00--30)M + [10] + **#**

LCD display

The keypad will beep twice to confirm it has been set, the keypad will return to previous setting. Press **←** + **←** + **#** back to standby interface.

### 5.5 Force arm

Factory default: disable

When there is zone fault, user will be not able to arm the device. But if set force arm, it is OK to arm, at the same time, the zone in fault will be bypassed with SMS or CMS report. E.g. Enable force arm

[012345] + \* + [0] + # + [5] + # + [5] + #

→ SYSTEM FORCE ARM: 1  
1>DISABLE 2>ENABLE + [2] + #

LCD display

The keypad will beep twice to confirm it has been set, the keypad will return to previous setting. Press ◀ + ◀ + # back to standby interface.

### 5.6 Emergency tone

Press the emergency help button, whether the external siren of the host emits an alarm sound. (default is mute). E.g. Set emergency alarm tone as ring

[012345] + \* + [0] + # + [5] + # + [6] + #

→ EMERGENCY TONE: 1  
1>MUTE 2>SOUND + [2] + #

LCD display

The keypad will beep twice to confirm it has been set, the keypad will return to previous setting. Press ◀ + ◀ + # back to standby interface.

### 5.7 AC off delay

When AC power failure occurs, the time of uploading the alarm center will be delayed. If the AC power is restored within the delay time, the AC power failure information will not be uploaded. The default is 30 minutes, and 0 means no delay. E.g. Set the AC power-off delay time to 5 minutes.

[012345] + \* + [0] + # + [5] + # + [7] + #

→ AC LOSS DELAY: 030  
(000--999)M + [005] + #

LCD display

The keypad will beep twice to confirm it has been set, the keypad will return to previous setting. Press ◀ + ◀ + # back to standby interface.

### 5.8 Door sensor check

Pull out the magnetic strip, whether to display the zone fault (default value is disable), example: set door sensor check to be enable.

[012345] + **\*** + [0] + **#** + [5] + **#** + [8] + **#**

→ DOOR SENSOR CHECK: **1**  
1>DISABLE 2>ENABLE + [2] + **#**  
LCD display

The keypad will beep twice to confirm it has been set, the keypad will return to previous setting. Press **←** + **←** + **#** back to standby interface.

### 5.9 WLS sensor loss: default value is 00 disable

Example: set detector loss check time is every 4 hours.

[012345] + **\*** + [0] + **#** + [5] + **#** + [9] + **#**

→ WLS SENSOR LOSS: **00**  
(00--99)H 0 DISABLE + [04] + **#**  
LCD display

The keypad will beep twice to confirm it has been set, the keypad will return to previous setting. Press **←** + **←** + **#** back to standby interface.

Note: wireless detector send status report is every 3 hours, if the panel do not receive the report or alarming information, the detector will be regarded as loss. Recommended sensor loss check time is every 4 hours or above.

### 5.10 Voice prompt

The host arm and disarm, alarm and other voice prompts.

For example: set to open local voice prompts.

[012345] + **\*** + [0] + **#** + [5] + **#** + [0] + **#**

→ VOICE PROMPT: **1**  
1>DISABLE 2>ENABLE + [2] + **#**  
LCD display

The keyboard beeps twice, indicating that the local voice prompt is successfully turned on. After setting, the keyboard will automatically return to the previous interface. Press **←** + **←** + **#** back to standby interface.

## 6. Set wireless



### 6.1 Set remote



#### 6.1.1 Enroll remote

Example: enroll remote to the #2 remote in alarm panel

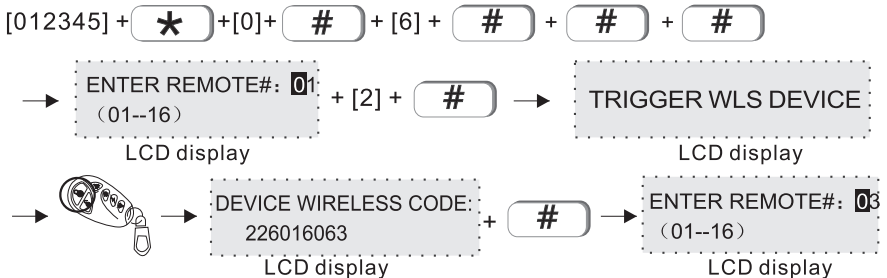

The keypad will beep twice to confirm it has been set, the keypad will return to previous setting. Press ◀ + ◀ + ◀ + # back to standby interface.

#### 6.1.2 Enter remote code

Example: manually enter the address code of remote 226016063 to be #3 remote in alarm panel

[012345] + \* + [0] + # + [6] + # + # + [2] + #

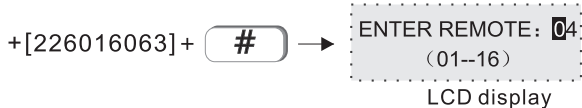

The keyboard beeps twice, indicating success. the keyboard will automatically enter the next remote adding. Press ◀ + ◀ + ◀ + # back to standby interface.

### 6.1.3 Delete remote

Example: delete #3 remote

[012345] + \* + [0] + # + [6] + # + # + [3] + #



+ #

The keyboard makes two beeps, indicating that the remote control has been deleted successfully. The keyboard will automatically enter the next delete interface, and press ◀ + ◀ + ◀ + # return to the standby interface.

**Note: enter 00 to delete all remotes**

### 6.2 Set WLS detector

[012345] + \* + [0] + # + [6] + # + [2] + #

- 1) ENROLL DETECTOR
- 2) DETECTOR CODE
- 3) DELETE DETECTOR



### 6.2.1 Enroll detector

Example: enroll detector to #2 detector in the alarm panel.

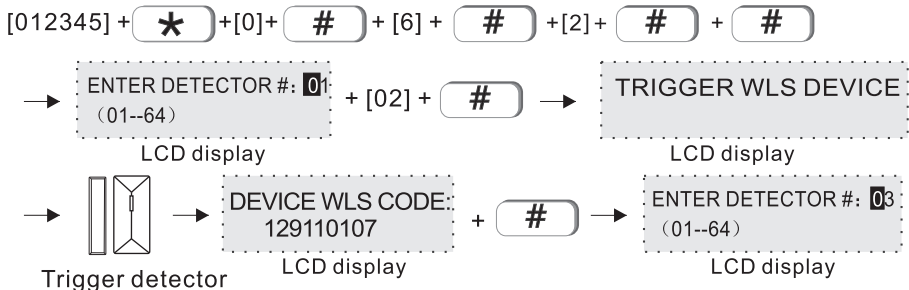

The keyboard beeps twice, indicating success. The keyboard will automatically enter the next detector adding. Press + + + back to standby interface.

### 6.2.2 Detector code

Example: manually enter the address code of detector 129110107 to be #3 detector in alarm panel.

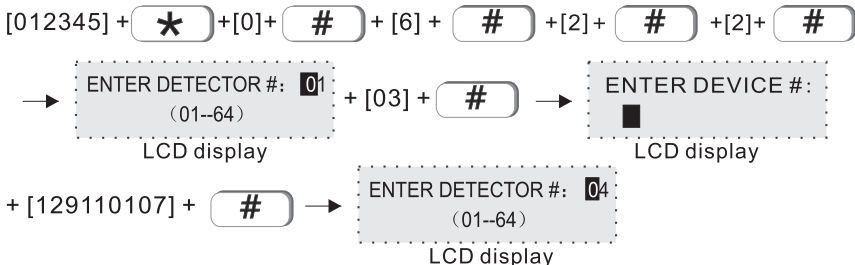

The keyboard beeps twice, indicating success. The keyboard will automatically enter the next detector adding. Press + + + back to standby interface.

### 6.2.3 Delete detector

For example: delete the #3 detector

[012345] + \* + [0] + # + [6] + # + [2] + # + [3] + #

→ ENTER DETECTOR #: 01  
(01-64) 00 DEL ALL → LCD display + [03] + # → DELETE DEVICE? → LCD display

+ # → ENTER DETECTOR #: 04  
(01-64) 00 DEL ALL → LCD display

The keyboard beeps twice, indicating success. The keyboard will automatically enter the next detector deleting. Press ◀ + ◀ + ◀ + # back to standby interface.

### 6.3 Set WLS siren

[012345] + \* + [0] + # + [6] + # + [3] + # → 1) ENROLL SIREN  
→ 2) DELETE SIREN

*Note: When the wired siren is not connected, it will display fault. If you don't want to connect wired siren, pls connect a 2.2k resistor to the wired siren port.*

#### 6.3.1 Enroll siren

Example: enroll siren to #2 siren in the alarm panel

[012345] + \* + [0] + # + [6] + # + [3] + # + #

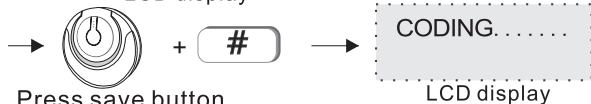

Press save button in the siren

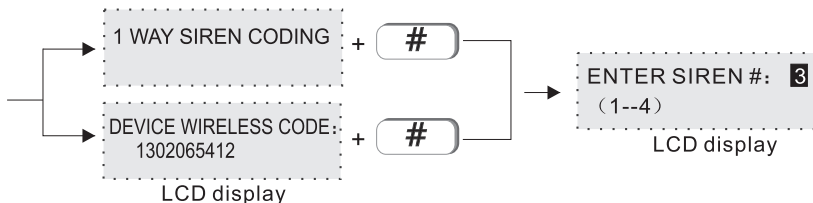

The keyboard beeps twice, indicating success. The keyboard will automatically enter the next siren adding. Press ◀ + ◀ + ◀ + # back to standby interface.

### 6.3.2 Delete siren

Example: delete #3 siren

[012345] + \* + [0] + # + [6] + # + [3] + # + [2] + #

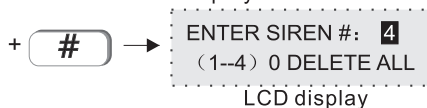
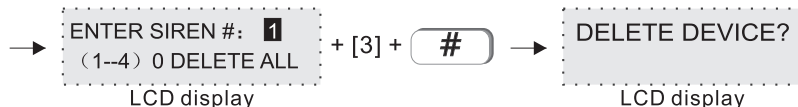

The keyboard beeps twice, indicating success. The keyboard will automatically enter the next siren deleting. Press ◀ + ◀ + ◀ + # back to standby interface.

### 6.4 RF switch

[012345] + \* + [0] + # + [6] + # + [4] + #

- 1) ENROLL SWITCH
- 2) ENTER SWITCH CODE
- 3) DELETE SWITCH

### 6.4.1 Enroll switch

Example: auto the wireless switch to the # 2 switch in alarm panel.

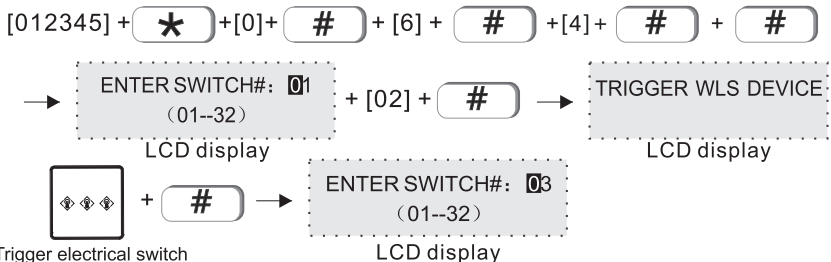

The keyboard beeps twice, indicating success. The keyboard will automatically enter the next switch adding. Press ◀ + ◀ + ◀ + # back to standby interface.

### 6.4.2 Enter switch code

Example:add a wireless switch code of 122095110 to No. 3 in alarm panel.

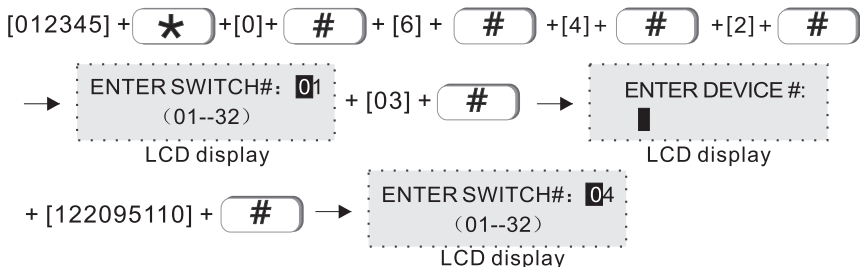

The keyboard beeps twice, indicating success. The keyboard will automatically enter the next switch adding. Press ◀ + ◀ + ◀ + # back to standby interface.

### 6.4.3 Delete switch

Example: delete the #3 switch.

[012345] + \* + [0] + # + [6] + # + [4] + # + [3] + #

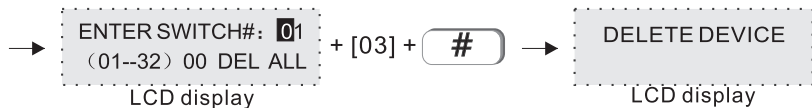

The keyboard beeps twice, indicating success. The keyboard will automatically enter the next switch deleting. Press ◀ + ◀ + ◀ + # back to standby interface.

## 7. Set system zone

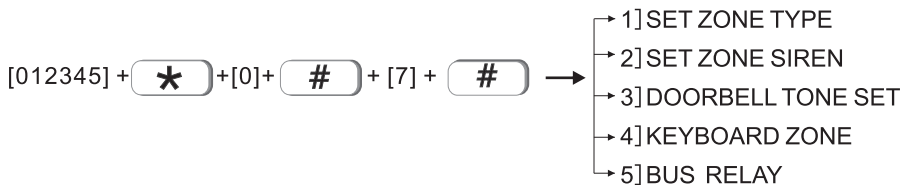

A zone can be assigned to one or more zones. A zone assigned to a single zone is determined by the status of the zone to alarm or not. A zone assigned to multiple zones is determined by the status of multiple zones. As shown in the figure below, zone 1 Armed and disarmed in partition 2, the public defense zone of partitions 1 and 2 will not alarm when triggered.

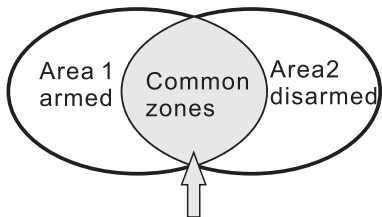

The common zone will not trigger alarm because of area2 is disarmed.

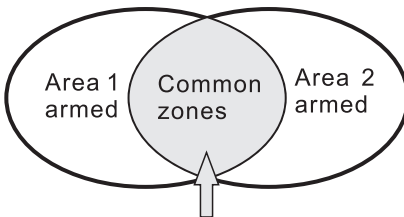

The common zones will trigger alarm because both of area 1 and area 2 are armed.

After the public defense zone alarms, the alarm message will be sent to all users in the partition, but there is an exception. When the other partitions to which the public defense zone belongs have been armed, the user in the last partition will alarm after the exit delay expires, without disturbing the other partitions.

The defense area supports naming. After the defense area is named, the short message and the keyboard will display the name of the defense area.

### 7.1 Set zone type

The options of zone types as below

0>disable	1>delay 1	2>delay 2	3>perimeter
4>interior	5>emergency	6>24H	7>fire
8>water Sensor		9>Key zone	

1. The zone type refers to the alarm type displayed by the host after the detector set in the zone alarms. When the zone type is 0, the zone disable. Triggering the zone in any state will not cause the host to alarm.
2. The alarm will only be triggered when the internal zone is in the armed state.
3. When the delay and perimeter zone is in the state of home arm, it will alarm when triggered.
4. In any state of emergency, 24-hour, or fire protection zone, it will alarm when triggered.
5. The wireless zone does not support key zone type. When the wired zone is set as key zone, the host will disarm if the zone is triggered. Mainly used for access control systems.
6. The key zone is only applicable to 1~8 wired defense zones.

#### Factory default value:

- 1~16 wired defense areas are disabled;
- 17~80 wireless defense areas are enabled;
- 81~128 keyboard extended defense areas are disabled;
- 129~256 bus extended defense areas are disabled;
- 257~320 single bus defense areas are disabled;
- 321-512 The CAN bus zone is disabled.

Example: Set Zone 8 to be fire zone.

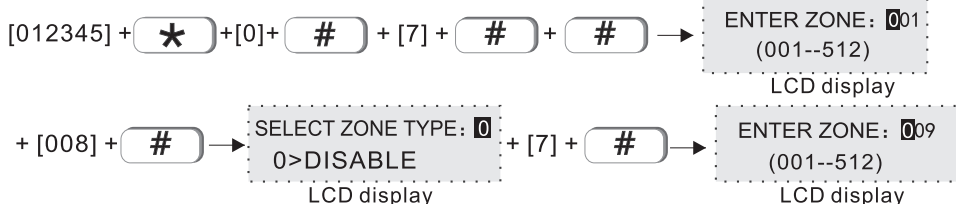

The keyboard beeps twice, indicating success. The keyboard will automatically enter the next zone type setting. Press ◀ + ◀ + ◀ + [#] back to standby interface.

### 7.2 Set zone siren: default value to be mute

Example: set zone 108 siren type to be pulse



The keyboard beeps twice, indicating success. The keyboard will automatically enter the next siren type setting. Press ◀ + ◀ + ◀ + [#] back to standby interface.

### 7.3 Doorbell tone set. Default is disable

Example: set zone #12 doorbell type as enable.

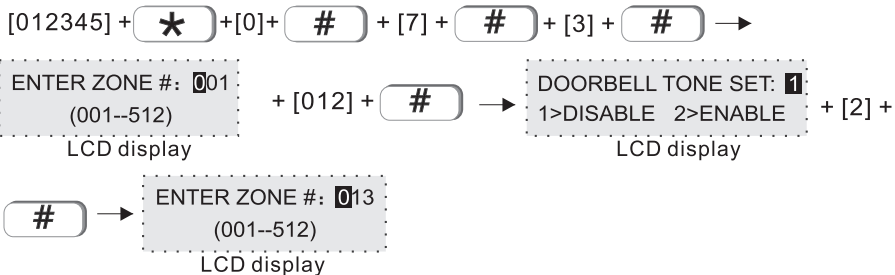

The keyboard beeps twice, indicating success. The keyboard will automatically enter the next doorbell type setting. Press ◀ + ◀ + ◀ + # back to standby interface.

### 7.4 Keyboard zone. Disabled by default

Example: enable keypad zone 5.

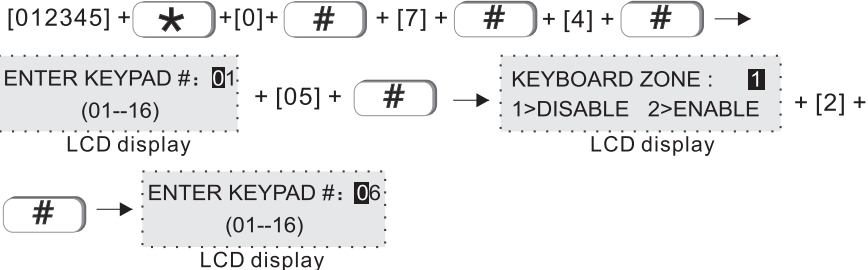

The keyboard beeps twice, indicating that the keyboard zone is successfully set. The keyboard will automatically enter the next keyboard zone setting. Press ◀ + ◀ + ◀ + # back to standby interface.

### 7.5 Bus relay





### 7.5.1 Relay enable

The machine has a total of 128 bus defense zones, and a single or all bus defense zones can be set to link a relay. When the linked zone triggers an alarm, the associated relay will output an alarm signal. For example: enable bus zone 135 linkage relay 2.

[012345] + **\*** + [0] + **#** + [7] + **#** + [5] + **#** + **#** →

ENTER BUS ZONE: **129**  
(129--256)(0 ALL) + [135] + **#** → ENTER RELAY NO.: **1**  
(1--2)

LCD display LCD display

+ [2] + **#** → RELAY ENABLE: **1**  
1>DISABLE 2>ENABLE + [2] + **#**

LCD display

The keyboard emits two beeps, indicating that the linkage setting is successful. The keyboard will automatically enter the next linkage setting. Press **←** + **←** + **←** + **#** back to standby interface.

**Note: When inputting the zone number, input 000 to select the linkage of all bus zones.**

### 7.5.2 NC/NO (Default is N.C.)

Set the linkage relay normally open and normally closed output.

For example: set bus zone 140 linkage relay 2 to be N.O..

[012345] + **\*** + [0] + **#** + [7] + **#** + [5] + **#** + [2] + **#**

→ ENTER BUS ZONE: **129**  
(129--256)(0 ALL) + [132] + **#** → ENTER RELAY NO.: **1**  
(1--2)

LCD display LCD display

+ [2] + **#** → ELAY TYPE: **1**  
1>N.C. 2>N.O. + [2] + **#**

LCD display

The keyboard makes two beeps, indicating that the N.O./N.C. setting is successful. The keyboard will automatically enter the next setting. Press **←** + **←** + **←** + **←** + **#** back to standby interface.

### 7.5.3 Output time (Default is 30 S)

Relay alarm output time. After the linkage time expires, it will return to N.O./N.C..  
 Example: Set the bus zone 156 linkage relay 2 and the recovery time is 60 S.

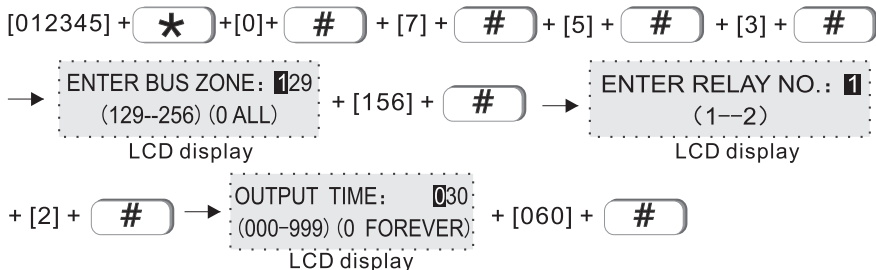

The keyboard emits two beeps, indicating that the linkage time setting is successful. The keyboard will automatically enter the next setting. Press ← + ← + ← + ← + # back to standby interface.

## 8. Set system area

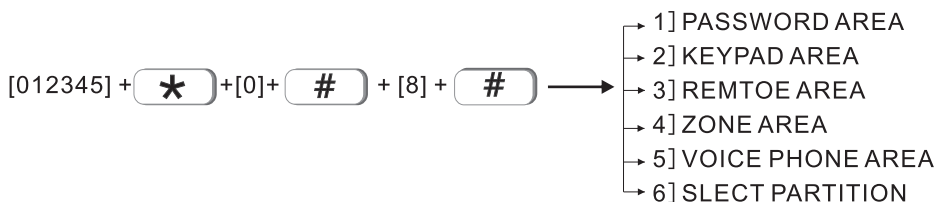

Total 8 areas, As shown in the example on the right, any defense area can be assigned to any partition. The defense area belonging to multiple partitions is a public defense area. The public defense area will only alarm when all the partitions it belongs to are armed. channel.

Keyboards and remotes can also be set up to manage one or more partitions. When the remote control manages multiple partitions, the operation of the remote control will work on all the partitions it manages at the same time. When the keyboard manages multiple partitions, it can operate on a partition alone or on multiple partitions at the same time. The operation depends on the permissions of the keyboard and the password used.

The voice phone can also belong to and manage one or

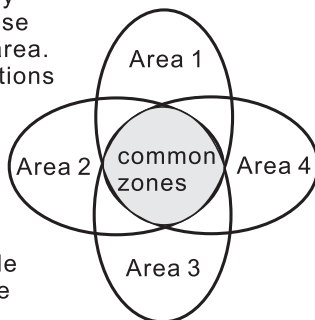

more partitions. When there is a message in the partition to which it belongs, it will be sent to the corresponding phone number.

Part 1 is the main partition, all system events are only reported to Part 1, and only Part 1 needs to be disarmed to enter the system settings.

### 8.1 Password area (default value is area 1)

1 user password can manage 1~8 area, example: set password 1 to manage area 1 and area 3

[012345] + \* + [0] + # + [8] + # + # →

ENTER PASSWORD#: 01 (01--32) + # → AREA: 12345678 (\*SEL) MANAGE: YNNNNNNNN + ▼

LCD display LCD display

+ ▼ + \* + # → ENTER PASSWORD#: 02 (01--32)

LCD display

The keyboard beeps twice, indicating success. The keyboard will automatically enter the next setting. Press ◀ + ◀ + ◀ + # back to standby interface.

Note: Y--enable N--disable

### 8.2 Keypad area (default value is area 1)

The keypad only display the assigned area information. Example: set keypad 1 to manage area 2.

[012345] + \* + [0] + # + [8] + # + [2] + # →

ENTER KEYPAD #: 01 (1--16) + # → AREA: 12345678(\*SEL) MANAGE: YNNNNNNNN

LCD display LCD display

+ \* + \* + # → ENTER KEYPAD #: 02 (1--16)

LCD display

The keyboard beeps twice, indicating success. The keyboard will automatically enter the next setting. Press ◀ + ◀ + ◀ + # back to standby interface.

### 8.3 Remote area (default value is area 1)

Example: set remote 1 to manage area 3.

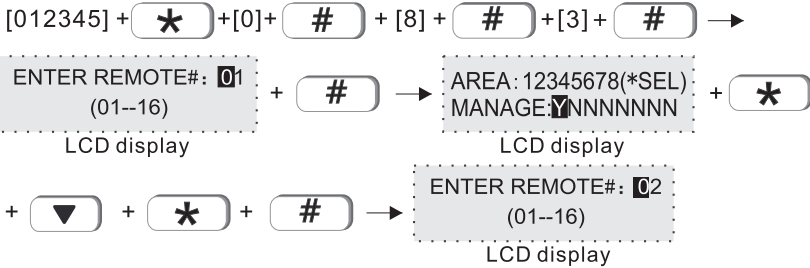

The keyboard beeps twice, indicating success. The keyboard will automatically enter the next setting. Press ◀ + ◀ + ◀ + # back to standby interface.

### 8.4 Zone area

Area armed: all zones that assigned to this area are armed.

Area disarmed: all zones that assigned to this area are disarmed.

Default value: area 1. Example: assign zone 55 to be area 3.

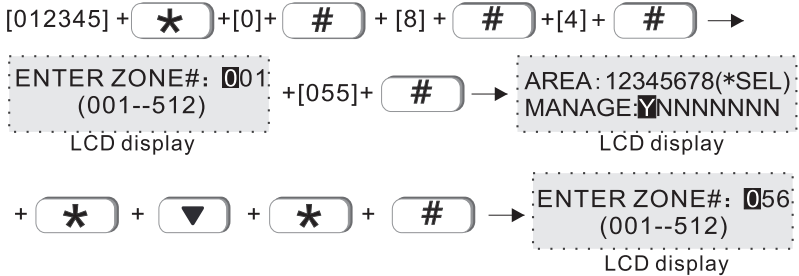

The keyboard beeps twice, indicating success. The keyboard will automatically enter the next setting. Press ◀ + ◀ + ◀ + # back to standby interface.

### 8.5 Voice phone area (default value is area 1)

User can set 4 voice phone numbers, example: set voice phone #1 to manage area2 and area 3.

[012345] + \* + [0] + # + [8] + # + [5] + # →

VOICE PHONE: 01  
(01--16) + # → AREA: 12345678(\*SEL)  
MANAGE: YNNNNNNN

LCD display                      LCD display

+ \* + \* + \* + # → VOICE PHONE: 02  
(01--16)

LCD display

The keyboard beeps twice, indicating success. The keyboard will automatically enter the next setting. Press ◀ + ◀ + ◀ + # back to standby interface.

### 8.6 Slect partition (default value is area 1)

You can set 4 time arm/disarm area.  
Example: Set timing 2 to control area 2 and 4.

[012345] + \* + [0] + # + [8] + # + [6] + # →

ENTER SERIAL NO.: 1  
(1--4) + [2] + # → AREA: 12345678(\*SEL)  
MANAGE: YNNNNNNN

LCD display                      LCD display

+ \* + \* + ▼ + \* + # → ENTER SERIAL NO.: 3  
(1--4)

LCD display

The keyboard beeps twice, indicating success. The keyboard will automatically enter the next setting. Press ◀ + ◀ + ◀ + # back to standby interface.

NOTE: Y is enable, N is disable.

## 9. Set others

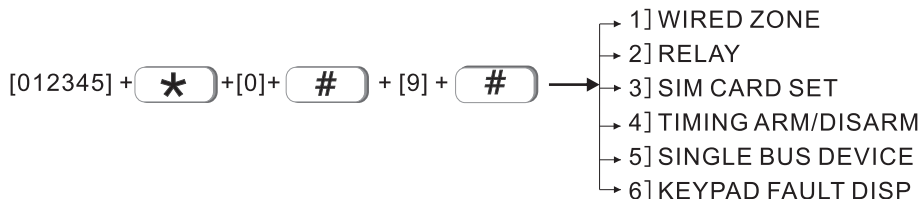

### 9.1 Wired zone

Set loop type of wired zone. Default is EOL type.

Exampel, set zone 3 loop type N. O

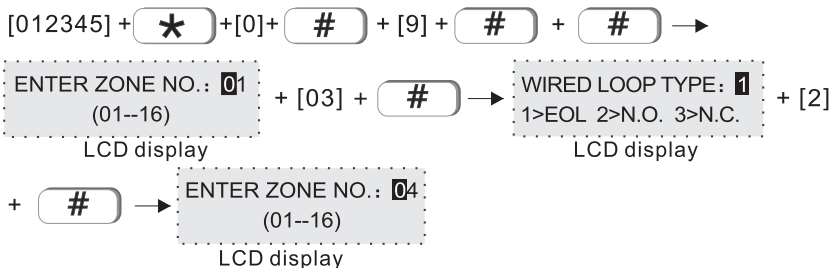

The keyboard beeps twice, indicating success. The keyboard will automatically enter the next setting. Press ◀ + ◀ + ◀ + # back to standby interface.

### 9.2 Relay

Set relay switch output type. Default is N. C

Example: Set relay # 15 with output type N. O

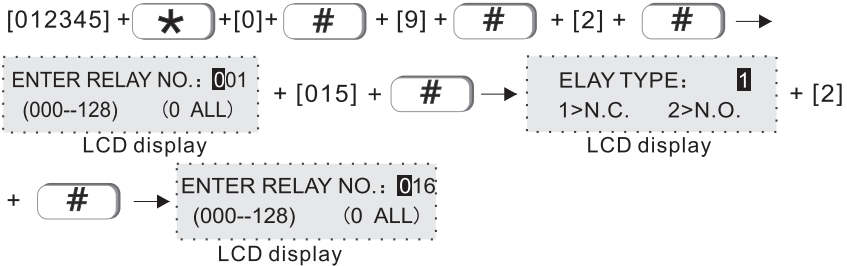

The keyboard beeps twice, indicating success. The keyboard will automatically enter the next setting. Press ◀ + ◀ + ◀ + # back to standby interface.

### 9.3 SIM card set

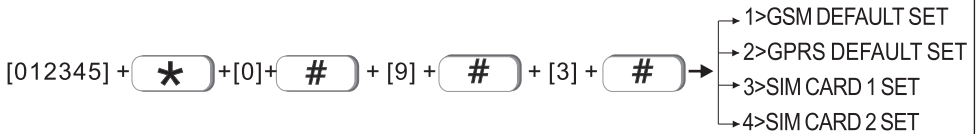

#### 9.3.1 GSM default set

The SIM card that is used first when the SIM card is enabled to make calls, send text messages, and other functions. The default is SIM 1 priority.

For example: Set SIM 2 priority.

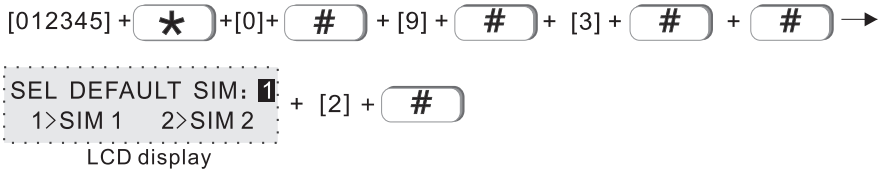

The keyboard makes two beeps, indicating that the SIM card priority setting is successful, the keyboard returns to the previous interface, press

◀ + ◀ + ◀ + # back to standby interface.





### 9.3.2 GPRS default set

The SIM card to be used first when enabling the SIM card to enable the network function. The default is SIM 1 priority.

For example: Set SIM 2 priority.

[012345] + \* + [0] + # + [9] + # + [3] + # + [2] + #

→  + [2] + #  
LCD display

The keyboard makes two beeps, indicating that the GPRS priority setting is successful, and the keyboard automatically returns to the previous interface, press  +  +  +  back to standby interface.

### 9.3.3 SIM card 1 set

Example: Set SIM card 1 mode as close.

[012345] + \* + [0] + # + [9] + # + [3] + # + [3] + #

→  + [0] + #  
LCD display

The keyboard beeps twice, indicating success. The keyboard will automatically return to previous setting. Press  +  +  +  back to standby interface.

### 9.3.4 SIM card 2 set

Pls refer to 9.3.3 SIM card1 setting



### 9.4 Timing arm/disarm

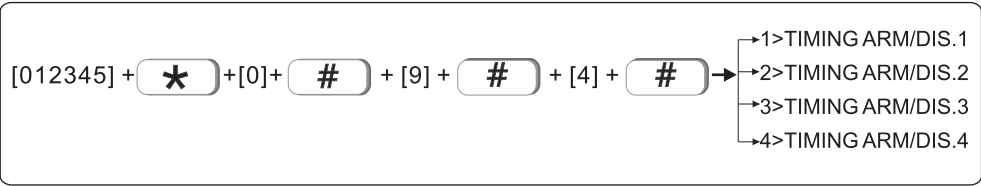

Automatically carry out arming / disarming operations at a certain time set. You can set 4 groups of timing arm/ disarm operations can be set, and the default is off. Among them, Y is enabled and N is disabled.

For example: set the timing arm /disarm 1 as arming, the time is 15:32, and the period is Monday to Friday.

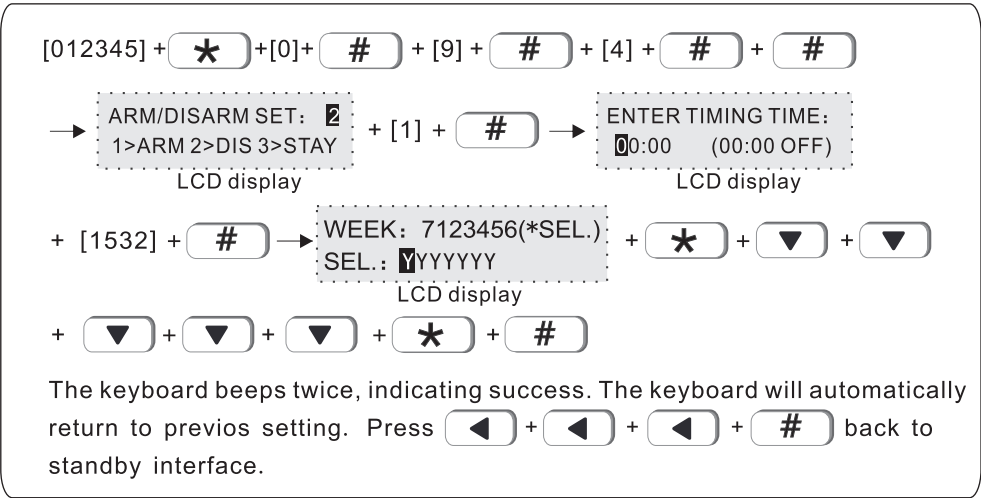

### 9.5 Single bus device

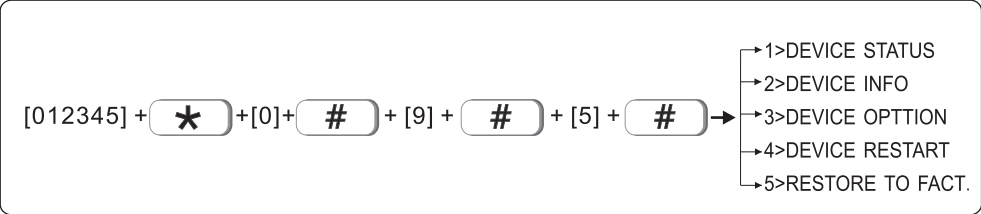

**9.5.1 Device status:** Refer to the following operations to check the device status.

Example, check the status of the vibration sensor with single bus device No. 2.

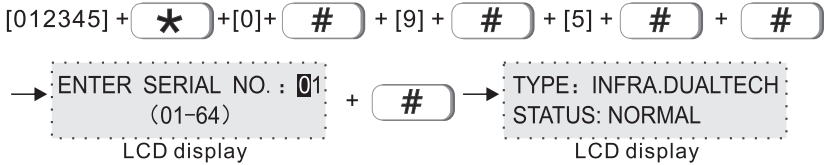

The keyboard beeps twice, indicating that the query is complete, press **#** to enter a number query, Press **◀** + **◀** + **◀** + **◀** + **#** back to standby interface.

**9.5.2 Device info:** You can check the hardware and software version of the device.

For example, check the version number of the infrared detector with the single-bus device No. 3.



The keyboard beeps twice, indicating that the query is complete, press **#** to enter a number query, Press **◀** + **◀** + **◀** + **◀** + **#** back to standby interface.

**9.5.3 Device option:** Different device types have different options to enter. Users should refer to the device manual to set them.

Please refer to the following operations to enter the device option settings.

[012345] + **\*** + [0] + **#** + [9] + **#** + [5] + **#** + [3] + **#**

→ ENTER SERIAL NO. : **1**  
(01-64)  
LCD display

Enter the serial number of the device and press # to enter the setting. The keyboard beeps twice, indicating that the setting is complete. Enter a setting item. Press **←** + **←** + **←** + **←** + **#** back to standby interface.

### 9.5.4 Device restart

For example: restart the device with serial No. 22.

[012345] + **\*** + [0] + **#** + [9] + **#** + [5] + **#** + [4] + **#**

→ ENTER SERIAL NO. : **01**  
(01-64)  
LCD display

+ [22] + **#**

→ DEVICE:02 RESTART?  
LCD display

+ **#** → ENTER SERIAL NO. : **23**  
(01-64)  
LCD display

The keyboard beeps twice, indicating that the restart setting is successful. After the setting is completed, it will enter the next device serial number.

Press **←** + **←** + **←** + **←** + **#** back to standby interface.

### 9.5.5 Restore to fact

Restore the device to the factory default settings.

For example: reset the device with the serial number 13 to factory settings.

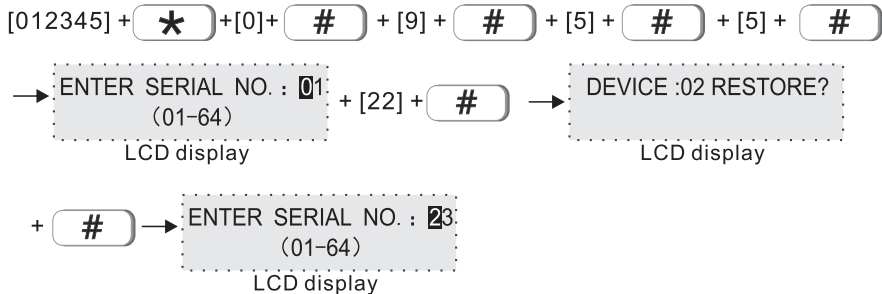

The keyboard beeps twice, indicating that the factory settings are restored successfully. Then enter the next device Serial number.

Press ◀ + ◀ + ◀ + ◀ + # back to standby interface.

### 9.6 Keypad fault disp

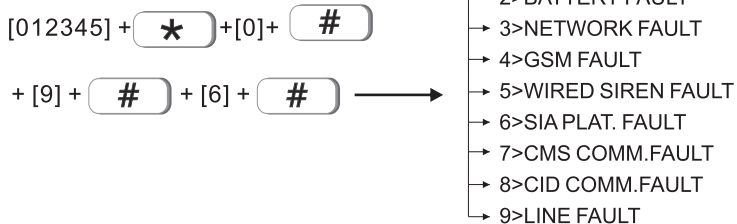

“ENABLE” the keyboard will display the fault, and “DISABLE” will not display it. (Enabled by default)

For example: Prohibition of wired siren failure.

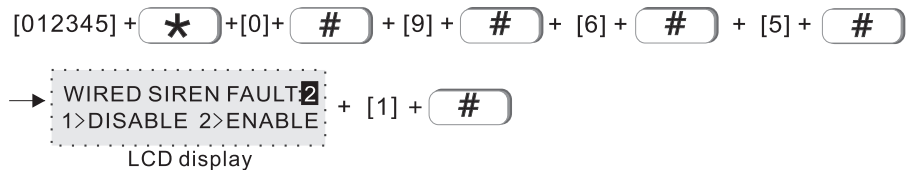

The keyboard emits two beeps, indicating that the wired siren fault display setting is successful, and the keyboard automatically returns to the previous interface, press ◀ + ◀ + ◀ + # back to standby interface.

## 10. Advanced set.

Without voice prompt, programme address and the corresponding options as below:

001--System Language	1	916--Detector_low_bat	13
002-- Ring Times	0~15	917--Detector_bat_ok	13
003--Communication Test Time	0~999H	918--Wireless_loss	13
004--Phone Line Detection	2	919--System_programme	13
005--Wireless Detector Tamper	2	920--Arm_fail	13
006--Arm/Disarm Siren Short Sound Tone	1	921--Comm_test	13
007--Web Port	0~65535	922--Event_bypass	13
008-- Limit of Alarming Times	1	923--Sys_bat_recovery	13
009--One-key Arm	1	924--Sys_comm_fault	13
010--First Communication Detection Time	0~23 H	925--Bypass_cancel	0
011--CMS Connection Mode	2	926--Comm_recovery	0
012--CMS Heartbeat Time	1~60S	927--Loop_fault	0
013--SIA Platform Connection Mode	1	928--Loop_recovery	0
014--Platform Heartbeat Time	1~9999S	929--Bell_fault	15
040--DTMF interval time	50-200mS	930--Bell_recovery	15
041--DTMF duration	50-200mS	931--Event_duress	15
100--GSM Module Signal	0~31	932--Delay_recovery	0
200--Restore to Factory Default	0	933--Perimeter_recovery	0
900--Event_delay	15	934--Interior_recovery	0
901--Event_perimeter	15	935--Emergenc_recovery	0
902--Event_interior	15	936--Hour24_recovery	0
903--Event_emergency	15	937--Fire_recovery	0
904--Event_24hour	15	938--SOS_recovery	0
905--Event_fire	15	939--Tamper_recovery	0
906--Event_water	15	940--Wls_loss_recovery	0
907--Event_panicv	15	941 --Pstn_fault	13
908--Event_tamper	15	942 --Pstn_recovery	13
909--Event_arm	13	943 --Module Removed	13
910--Event_disarm	13	944--Water_recovery	13
911--Event_home	13	945--Password Error	13
912--System_low_bat	13	946--Program Entry	13
913--System_ac_fault	13	947--Program Exit	0
914--System_ac_ok	13	948--Bat_loss	13
915--Alarm_cancel	13	949--Bat_loss_recovery	13
		950--Bat_fault	13
		951--Bat_fault_recovery	13

1. 001—System Language: 1. Chinese 2. English  
 002—Ring Times (the default setting is 3 times) : set value 0~15. 0 means not answering the call.  
 003—Communication Test Time: set value 0~999H. 0 means no test.  
 004—Phone Line Detection: 1. No detection, 2. Detection  
 005—Wireless Detector Tamper: 1. Disable 2. Enable  
 006—Arm/Disarm Siren Short Sound Tone: 1. No voice 2. Siren short sound  
 007—Web Port : set value 0~65535. (the default value is 80)  
 008—Limit of Alarming Times: 1. No limited 2. 3 Times limited  
 009—One-key Arm: 0. Disable 2. Enable  
 010—First Communication Detection Time: 0~23H  
 011—CMS Connection Mode: 1. No authentication 2. Authentication  
 012—CMS Heartbeat Time: 1~60s  
 013—SIA Platform Connection Mode: 1. Backup mode 2. Double report mode  
 014—SIA Platform Heartbeat Time: 1~9999s 100--  
 GSM Module Signal: Display current signal value 0~32, cannot be set  
 200—Restore to Factory Default: 0. Do not restore to factory default  
 1. Restore to factory default
  
2. #900-948 Alarm Event, the value above is factory default.
  
3. Set Alarm event notification as below:
 

0>Do not send any info.	1>CMS ONLY	2>Voice number only
3>CMS+Voice number	4>SMS ONLY	5>CMS+SMS
6>Voice number+SMS	7>CMS+Voice number+SMS	
8>Email	9>CMS+Email	10>Voice number+Email
11>CMS+Voice number+Email	12>SMS+Email	
13>CMS+SMS+Email	14>Voice number+SMS+Email	
15>CMS+Voice number+SMS+Emai		

## On-screen instructions



Programming address          Data

Press the up and down keys to view and modify the data of different data bits.  
 For example: set Ring Times to 5.

[012345] + **\*** + [0] + **#** + [0] + **#** → ADVANCED OPTION : \*DEL

+ [00205] + **#** LCD display

The keyboard beeps twice, indicating that the setting is successful. Then the keyboard will automatically return to the previous interface.

press **◀** + **◀** + **#** back to standby interface.

## II. Web introduction

Enter the System setting of host, set the IP address and gateway in the network settings.

### 1. Access to the host

Users can use the web page administrator account, the main user account, and the user account to log in to the web page. Different account types have different permissions. The web page administrator account has the highest permissions, and the main user account has some permissions. The user account needs to set permissions on the keyboard. You can log in to the web page, and you can set up 32 user accounts through the web administrator or the main user.

It is recommended to use Google Chrome to access the host.

**Method 1:** Open a browser and enter the 12-digit IP address of the host in the address bar and press Enter to confirm;

**Method 2:** Enter `http://meian_panel` in the URL bar of the browser to log in.

Enter the user name and password in the pop-up dialog box and click OK.

The user name and password are both factory default settings. If there is any change, please refer to the changed one.

Web page administrator account: admin, password: admin

Main user account: main user, password: 1234

User account: user 01, password: 1234

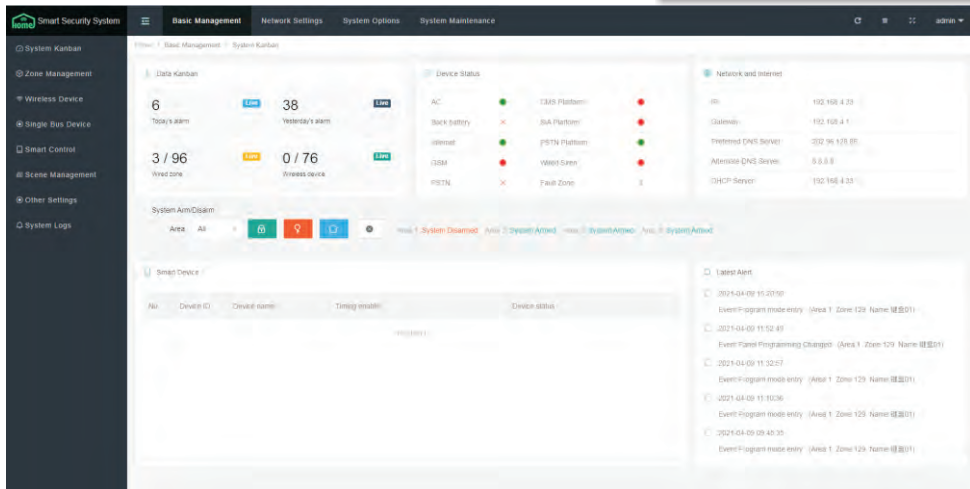
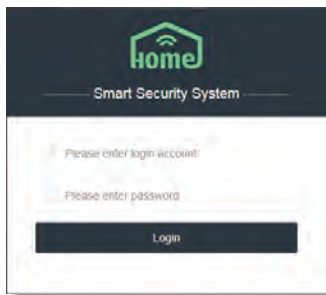

## 2. Basic management

### 2.1 System Kanban

System Kanban can view real-time data of Device Status, Network and Internet, System Arm/Disarm, Smart Device, Latest Alert, etc.

**Data Kanban:** Display the real-time data of Today's alarm, Yesterday's alarm, Wired zone, and Wireless device.

**Device Status:** the connection status of AC, Platform, Back battery, etc. The green circle means connected, the red circle means fault, and "X" is the unsupported item of the device.

**Data Kanban**

6 Today's alarm	Live	38 Yesterday's alarm	Live
3 / 96 Wired zone	Live	0 / 76 Wireless device	Live

**Device Status**

AC	●	CMS Platform	●
Back battery	×	SIA Platform	●
Internet	●	PSTN Platform	●
GSM	●	Wired Siren	●
PSTN	×	Fault Zone	3

**Network and Internet:** Current Network IP address and Gateway information.

Network and Internet	
IP	192.168.4.33
Gateway	192.168.4.1
Preferred DNS Server	202.96.128.86
Alternate DNS Server	8.8.8.8
DHCP Server	192.168.4.33

**System Arm/ Disarm:** Select the Area and click the Arm/ Disarm icon to arm /disarm the area.

System Arm

System Disarm

System Stay

Cancel Alarm

**System Arm/Disarm**

Area: All

Area1 Disarm Area2 Disarm Area3 Disarm Area4 Disarm Area5 Disarm Area6 Disarm Area7 Disarm Area8 Disarm



## 2.2 System management

To set the zone attributes and zone information, please select the zone number according to the device type to add the zone. 1-16: wired defense area; 17-80: wireless defense area; 81-128: keyboard extended defense area; 129-256: bus extended defense area; 257-320: single bus defense area; 321-512: CAN bus defense area. Red “ ● ” means alarm, green “ ● ” indicates that the alarm has been cleared.

**Bypass:** It means that the defense zone is temporarily faulty when arming, so that it cancels the alert state. After disarming, the zone will return to the normal zone. When the zone is faulty, in order not to affect the use of the system, the zone can be set as a bypass zone.

Zone code	Zone name	Zone type	Area	Siren	Chime	Zone alarm	Tamper Al.	Loop fault	Battery fault	Lost fault	Operation
1	Unnamed	Delay zone 1	1 2 3 4	Continuous tone	ON	●	●	●	●	●	
2	Unnamed	Delay zone 1	1 2 3 4	Continuous tone	ON	●	●	●	●	●	
3	Unnamed	Unused	1 2 3 4	Continuous tone	ON	●	●	●	●	●	
4	Unnamed	Unused	1 2 3 4	Continuous tone	ON	●	●	●	●	●	
5	Unnamed	Unused	1 2 3 4	Continuous tone	ON	●	●	●	●	●	
6	Unnamed	Unused	1 2 3 4	Continuous tone	ON	●	●	●	●	●	
7	Unnamed	Unused	1 2 3 4	Continuous tone	ON	●	●	●	●	●	
8	Unnamed	Unused	1 2 3 4	Continuous tone	ON	●	●	●	●	●	
9	Unnamed	Delay zone 1	1 2 3 4	Continuous tone	ON	●	●	●	●	●	
10	Unnamed	Delay zone 1	1 2 3 4	Continuous tone	ON	●	●	●	●	●	
11	Unnamed	Interior zone	1 2 3 4	Continuous tone	ON	●	●	●	●	●	
12	Unnamed	Interior zone	1 2 3 4	Continuous tone	ON	●	●	●	●	●	

Click the icon “ ” to make settings.

**Zone code:** The zone number of the device, and the wired zone number corresponds to the terminal number of the wired zone of the host;

**Zone name:** Please set by yourself;

**Zone type:** Please refer to "7.1 Set zone type";

**Area:** A zone can be assigned to one or more areas. For the relationship between zones and areas, please refer to manual "7. Set system zone";

**Siren :** Mute, Continuous tone, and Pulse tone can be selected.

Modify zone info. ✕

Zone No.

Zone name

Zone type

Area  Area1  Area2  Area3  Area4  Area5  Area6  Area7  Area8

Siren

Chime  No

**Chime:** When the alarm is triggered, the host will emit two “dingdong” sounds; After setting, click "Save" to take effect, and click "Close" to not save.

### 2.3 Wireless device

**Auto search:** Click “Auto search” to trigger the wireless device to automatically check the code. Note that the trigger of the wireless device must be within 30 meters from the host;

No.	Device type	Wireless code	Device name	Area	Operation
1	Remote	00440000F	Remote01	1 2 3 4 5 6 7 8	

Total 1 Article   Previous page: 1   Next page: 12 Article/Page

**Add manually:** Manually enter the 9-digit address code of the wireless device to add. As shown in the figure, the device type includes Remote, Detector, Electrical switch, and Siren. Set the Device number and Device name when adding, and check the area and enter the 9-digit wireless address code at the bottom of the device. For example, if you want to add Electrical switch, please select the corresponding switch channels. After setting, click “Save” to take effect. Click this icon “” to modify the device, click this icon “”

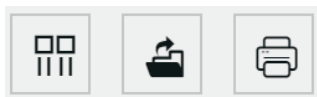

Filter column   Export   Print

**Filter column:** Display of chart items, which can display Device type, Wireless code, Device name, Area, Operation, and it will not be displayed if it is unchecked.

**Export:** Export the added device information to Excel format.

**Print:** Print out the added device information on paper.

## 2.4 Single bus device

64 single-bus devices can be added, please refer to the device manual to set the single-bus device address code (ie device number). After the setting is completed, wait for a while to find the device in the list. To restart and restore factory settings, you need to enter the administrator password (the default is 012345).

Single bus device list

Device number	Device type	Zone name	Device State	Hardware version	Firmware version	Operation
1	Device not connected	detector				
2	Dual Tech Infrared & MW	Unnamed	Normal	V1.01	V0.01	<a href="#">Settings</a> <a href="#">Restart</a> <a href="#">Reset</a>
3	Device not connected	Unnamed				
4	Device not connected	Unnamed				
5	Device not connected	Unnamed				
6	Device not connected	Unnamed				
7	Device not connected	Unnamed				
8	Device not connected	Unnamed				
9	Device not connected	Unnamed				
10	Device not connected	Unnamed				
11	Device not connected	Unnamed				
12	Device not connected	Unnamed				

12 in total | 1 | 2 | 3 | Next | 12 Article / Page | Skip | 1 Page | Confirm

## 2.5 Smart control

Smart control means remote control and setting of wireless switch name and timing automatic switch. The device name can be modified in “Wireless Device”. Other setting items can be directly clicked to modify or check, multiple loops can be timed, and the operation of the device is the operation (open or closed) performed during the time period.

No.	Device ID	Device name	Timing enable	Timing on	Timing off	Timing correlation loop	Operation
1	150000005	Switch	<input checked="" type="checkbox"/>	00:00	00:00	<input checked="" type="checkbox"/> <input checked="" type="checkbox"/>	<input type="radio"/> OFF <input checked="" type="radio"/> ON <input type="radio"/> OFF

1 in total | 15 Article / Page | Confirm

## 2.6 Scene management

Scene management includes Zone linkage, Relay linkage, Electrical switch linkage, and PGM linkage.

Zone linkage: Set up two associated zones, and the alarm will only be triggered when two zones are triggered within the effective time.

**Mode 1:** No sequence. Alarm will be triggered within the setting time, when two zones are triggered at the same time.



**Mode 2:** There is a sequence. Only when Zone 2 is triggered first, then Zone 1 is triggered within the setting time range, the alarm will be triggered. and it will not alarm if Zone 1 is triggered first , then zone 2 is triggered;

**Mode 3:** There are sequence and direction. Trigger Zone 2 and then trigger Zone 1, it will make alarm. Trigger Zone 1, and then trigger Zone 2 , the alarm is not triggered, and return to no alarm within the setting time range . For example: Zone 1 → Zone 2 → Zone 2 → Zone 1 .

Scene management

Zone linkage   Relay linkage   Electrical switch linkage   PGM linkage

Add zone linkage

No.	Enable/Disable	Associated zone 1	Associated zone 2	Mode	Effective time	Operation
1	Enable	1	2	1	1	 

1 Skip 1 Page Confirm 1 in total 10 Article / Page

**Relay linkage:** The Type of alert you set is triggered within the effective time, and the relay in the alarm area performs an output or recovery action.

Click "Add relay linkage" to enter the interface on the right. The Event type can be divided into Area event, Zone event, and System event. Different Event type can choose different Type of alert. The Area number is the alert trigger area. Up to 8 relay numbers can be linked. Click "Save" after setting.

Add relay linkage scene

Enable/Disable  ON

Event type Area event

Type of alert You can only choose 8 at most

Area number Area 1

Relay number You can only choose 8 at most

Action  Output  Recovery

Effective time Please enter the effective time (0-999 seconds)

Save Close

**Electrical switch linkage/ PGM linkage:** Triggering the setting alert within the effective time will execute the action of turning on or off of the electrical switch/PGM.

## 2.7 Other settings

### 2.7.1 Wired zone settings

Wired zone loop type: EOL, N.O., N.C..And the default is EOL.

**EOL:** When the resistance at the end of the line in the zone is 2.2K, it is normal, and the zone will alarm if it is open circuit or short circuit;

**N.O.:** the open circuit in the zone is normal, and it alarms when it is under the short circuit;

**N.C.:** the short circuit in the zone is normal, and it alarms when it is under the open circuit.

After the setting is completed, click “Save” to take effect.

### 2.7.2 Bypass group setting

A bypass group can select up to 16 defense zones, and up to 8 bypass groups can be set. Click the drop-down window "▼" to select.

Bypass group setting

Bypass group number

Zone number

### 2.7.3 Relay settings

Relay circuit type: N. C. / N. O. mode can be selected, and the default mode is N. C.

Relay settings

Relay number

Loop type  N.O.  N.C.

### 2.7.4 Keyboard area settings

Assign the keyboard to one or more areas, then select the keyboard number. The keyboard name can be modified. Check the area, and click “Save” to take effect.

Keyboard area settings

Keyboard number  Keyboard name

Enable/Disable Zone  OFF (Keyboard expansion zone)

Area  Area 1  Area 2  Area 3  Area 4

### 2.7.5 Keyboard fault display

When the network cable or phone card is not inserted or not inserted properly, the keyboard display screen shows the Network fault, and the fault can be removed by inserting the network cable or phone card properly. And you can also disable this fault in this setting, and the keyboard display will not display the fault. All display is turned on by default, and the user must click Save after completing the settings.

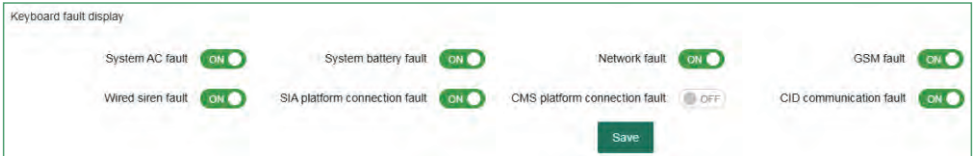

## 2.8 System log

The system log can query the system event records of partitions/defense zones /users, and can store up to 1000 event records cyclically.

System log						
<a href="#">Clear all logs</a>						
No.	Area code	Zone code	Zone name	Alarm event	Alarm time ↕	
1	4	155	CMS/APP	Disarm	2021-04-09 16:25:25	
2	3	155	CMS/APP	Disarm	2021-04-09 16:25:25	
3	2	155	CMS/APP	Disarm	2021-04-09 16:25:25	
4	1	155	CMS/APP	Alarm Cancel	2021-04-09 16:25:25	
5	1	9	Door	Tamper	2021-04-09 16:25:19	
6	1	129	Keyboard 01	Program mode entry	2021-04-09 15:20:50	
7	1	129	Keyboard 01	Panel Programming Changed	2021-04-09 11:52:49	
8	1	129	Keyboard 01	Program mode entry	2021-04-09 11:32:57	
9	1	129	Keyboard 01	Program mode entry	2021-04-09 11:10:36	
10	1	129	Keyboard 01	Program mode entry	2021-04-09 09:45:35	
11	1	129	Keyboard 01	Program mode entry	2021-04-09 09:06:12	
12	1	129	Keyboard 01	Panel Programming Changed	2021-04-08 17:37:39	

242 in total    [Previous](#)    **1**    [2](#)    [3](#)    [4](#)    [5](#)    ...    [21](#)    [Next](#)    12 Article / Page    [Skip](#)    [1](#)    Page    [Confirm](#)

The composition of the zone number is as follows:

Device Zone Number		User action number	
Zone No.	Definition	Zone No.	Definition
1~16	Wired zone	533~548	16 remote controls
17~80	Wireless zone	550	Platform
81~128	Keyboard expansion zone	552	Key defense zone
129~256	Bus expansion zone	555	Web client
257~320	Single bus zone	560~575	Voice phone
321~512	CAN bus zone	580~583	Timed arming and disarming
513~528	16 keyboard defense zones	590	Main user password
529~532	Wireless siren	591~622	32 user passwords

### 3. Network settings

#### 3.1 TCP/IP settings

You can set the host name, IP address, subnet mask, default gateway and other information. The MAC address cannot be changed. If the DHCP function is enabled, the above information changes are invalid, and the host IP address is displayed in the automatically assigned IP address column.

**TCP/IP Settings**

Host name

IP address

Subnet mask

Default gateway

Preferred DNS

Standby DNS

MAC address

DHCP  OFF

IP address auto-configuration

Web port



### 3.2 GPRS settings

This setting is for the host to use GPRS to access the network, and the default SIM card network will be used first. When the default SIM card fails, the backup SIM card network will be enabled. SIM card 1 is limited to 2G network, and SIM card 2 supports 2G/4G network. This device does not support 5G currently. APN, APN user and APN Password are provided by the operator. Please click "Save" after setting.

#### SIM card management

Default SIM card  Card 1  Card 2

[Save](#)

#### SIM 1 Settings

Mode

APN

APN user

APN PWD

Dial codes  \*If you don't understand this setting, please consult your SIM card supplier

[Save Settings](#) [Reset](#)

#### SIM2 Settings

Mode

APN

APN user

APN PWD

Dial codes  \*If you don't understand this setting, please consult your SIM card supplier

[Save Settings](#) [Reset](#)

### 3.3 Email settings

- a. SMTP server: fill in the SMTP server address that you want to send mail correctly, if you use 163 mailbox, the SMTP server address is: smtp.163.com
- b. SMTP port: The default is 25 (SSL encryption port is not supported temporarily)
- c. Mailbox login password: the password or authorization code of the sending mailbox, please fill in according to the actual situation.
- d. The sending mailbox needs to log in and enter the mailbox settings, and enable the SMTP mail. If it is not turned on, the mail cannot be sent.

#### Email Settings

Enable/Disable  OFF

SMTP server

SMTP server port

Email login username

Email login password

Sender's email address

Recipient's email address

### 3.4 CMS platform

The IP of the alarm platform/registered platform can be set under this setting item, and the alarm information can be uploaded to the platform after it is turned on. If you choose to set manually, you need to apply for a registration ID before you can upload information.

**Authentication :** After checking, automatically obtain the server address, port number, ID and other information and connect to the platform. Turn it on, click "Save Settings" and restart the device to go online on the CMS platform.

Turning on and off the platform will restart the device.

If you need to fill in manually, please turn off authentication first.

**Alarm platform server and port:** Fill in according to the server.

**Heartbeat time:** Refers to the time interval for the device to send a heartbeat message to the platform the last time it was sent. At every heartbeat interval, the device will send heartbeat information to the platform. After receiving the heartbeat information, the platform will record the time of receiving the heartbeat. If the heartbeat information of the device is not received for three consecutive heartbeat intervals, it is considered that the device is offline, and the offline time is recorded in the platform data.

### CMS Platform Settings

Authentication

Alarm platform server

Alarm platform server port

Platform user ID

Platform user password

Heartbeat time

### 3.5 SIA platform

The alarm platform mode can be set to single-platform connection mode or dual-platform connection mode.

In Single platform connection mode, if the Main alarm platform is disconnected and reconnected more than 5 times, the host will start the Backup alarm platform connection. At this time, the Main alarm platform is still trying to connect. When the Main alarm platform is restored, the Backup alarm platform will actively disconnect. When the voice platform of the Main alarm platform is successfully sent, it will not be sent to the Backup alarm platform again.

In Dual platform connection mode, the host will connect to two platforms at the same time, and the alarm information will be sent to both platforms at the same time. When the network is abnormal, the host will start GPRS, and when the GPRS

is abnormal, the host will start GSM to send data.

After the setting is completed, click “Save Settings” to take effect after restarting.

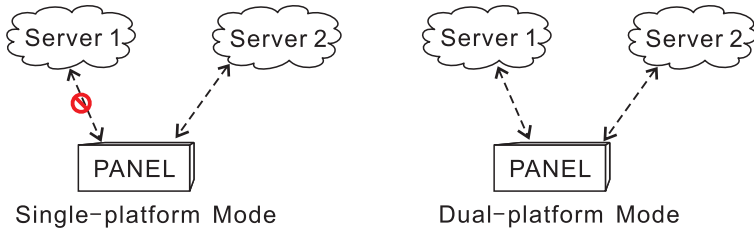

SIA Alarm Platform Settings

Enable/Disable  ON

Main alarm platform server

Main alarm platform server port

Main platform user ID

Main platform user password

Backup alarm platform server

Backup alarm platform server port

Backup platform user ID

Backup platform user password

Heartbeat time

Heartbeat time  Single platform connection mode  
 Dual platform connection mode



### 3.6 PSTN alarm platform settings (Ademco Contact ID protocol)

When setting the alarm call, enter “P” in the phone number, and the dialing will pause for 1 second.

The number of dialing is 5 times by default. When the alarm is triggered, the host will make a call to the alarm receiving platform. When the phone number 1 is not connected, the host will automatically dial the phone number 2, and make a circular call within the number of dialing set by the user.

The number of users can be 0 to 9, B, C, D, e and F. the interval of communication detection is to set a period of time, and the host will automatically communicate with the alarm center to detect whether the communication is normal.

**PSTN Alarm Platform Settings**

Enable/Disable  ON

CMS phone number 1

CMS phone number 2

User No.

Dialing times  (1-15 times)

## 4. System options

### 4.1 Alarm Parameter Settings

**1> Entry delay time:** it is only effective for the delay zone, and there is no entry delay for other types of zones. It is convenient for users to disarm the host before the host alarm takes effect, and the alarm information will not be uploaded to the alarm center.

**2> Exit delay time:** after user arm the host, it is convenient for user to leave before the host is armed.

**3> Siren duration:** the ringing time of siren after the host alarm (default:5 minutes).

**4> Detector loss detection time:** within this time period, the host inspects if receive any status report or alarm from the detector. If not, the host will show this

detector lost.

**5> AC power detection time:** After AC power failure, it is the time that the host delay to upload report information to the alarm center (default is 30 minutes).

**6> Communication detection interval:** set a period of time, the host will automatically communicate with the alarm center once to detect whether the communication is normal (default is 0).

Alarm Parameter Settings		
Entry delay 1	<input type="text" value="30"/>	(0~255 seconds)
Entry delay 2	<input type="text" value="45"/>	(0~255 seconds)
Exit delay	<input type="text" value="10"/>	(0~255 seconds)
Siren duration	<input type="text" value="5"/>	(0~30 minutes)
Detector loss detection time	<input type="text" value="0"/>	(0-99 hours), set 0 to close the wireless loss detection function
AC power detection time	<input type="text" value="30"/>	(0-99 minutes)
Communication detection interval	<input type="text" value="0"/>	(0-999 hours), 0 does not send detection report

**7> Arm/disarm tone:** when the user arm/disarm the host with the remote control, the siren will sound for a short time (the default is disable).

**8> Alarm limit:** the number of times that the host alarms several times continuously and the alarm information is uploaded to the alarm receiving center. When the alarm number reaches the limit in the arm status, the alarm triggered will be ignored.

**9> Door sensor detection:** if enable, when the magnetic strip is open, it will show the zone fault (default is disable).

**10> Detector disassembly detection:** when the detector is removed, the host will alarm. (the default is enable).

**11> Force arm:** when enable force arm, system still can be force armed when zone are in trouble and trouble zones will be bypassed automatically and system will send bypass report to user and alarm receiving center. When disable force arm, system can not be armed when zones are in trouble. (factory default: disable)

**12> Quick arm:** if enable, user can arm the system via keypad without entering password. If disable, user need to enter password to arm via keypad. Click save

after setting.

**13> Local voice prompt:** arm/disarm/alarm voice prompt and so on in host. (factory default: enable)

**14> Emergency alarm tone:** when alarm, the host is mute or ring. (factory default: mute)

**15> Host disassembly detection:** when the host is removed, the alarm will be triggered. If disable, it will not give alarm.

Arming alert tone  ON

Door sensor detection  OFF

Force arming  OFF

Local voice prompt  OFF

Host disassembly detection  ON

Alarm limit  OFF

Detector disassembly detection  ON

Quick Arm  OFF

Emergency alarm tone  OFF

Save Settings Reset

## 4.2 Alert settings

When the alarm is triggered, the system will upload to the alarm platform, make voice calls, send SMS and send E-mails. User select to enable. After setting, click “Save Settings”.

Alert Settings

Type of alert

Associated action  Upload alarm platform  Make a voice call  Send messages  Send email

Save Settings Reset

The host will give priority to the network to send messages. When the network fails, it will enable GPRS to connect to the platform. When the network platform fails, the host will send data to the telephone alarm platform through GSM or PSTN, and the host will give priority to PSTN to send data.

The host can choose whether to send the data to the user or platform, and how to send it to the user. When the network fails, GPRS will be enabled to connect to the platform; when the network fails, the host will send the data to the telephone alarm platform through GSM or PSTN, and the host will give priority to PSTN. As shown in the figure below:

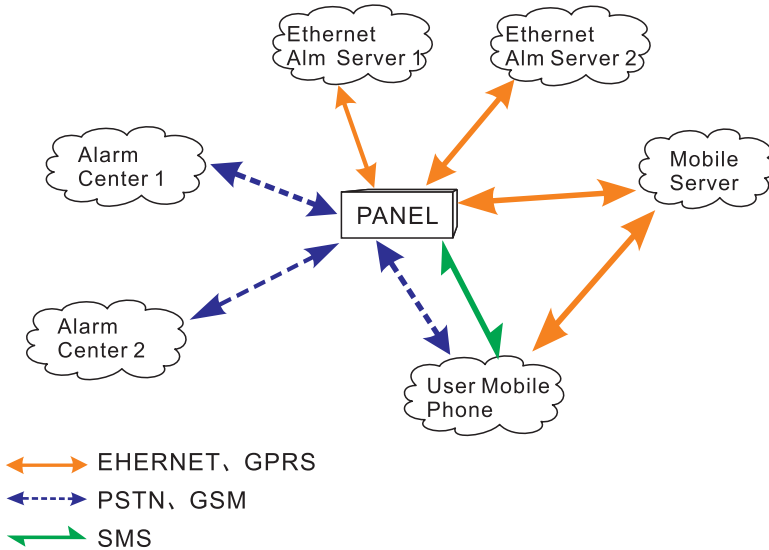

### 4.3 Password settings

**Web administrator:** the default account and password both are “admin”. Password settings should be case sensitive. Click “save” after changing.

**System administrator:** user can enter the keypad to set the host. The default password is 012345.

**Password Settings**

Web administrator

Username:  Old password:  New password:

---

System administrator

Password:



**Primary user:** it is used to login web page, password is 1234 by default. User can modify some settings in web IE interface.

**General user:** The default web page control, electrical switch control, PGM control, and relay control are disabled for ordinary user permissions, and the system arm, system disarm, system stay, zone bypass, and voice call control permissions are enabled. To enable or disable the permissions, please First enter the project settings to set. An ordinary user can manage 1~8 partitions. When the web page control authority is enabled, the user name and password can log in to the web page to view the settings. After setting, click "Save to take effect".

**Main user**

---

Main user name:  Password:

**Common user**

---

No.

username:  Password:

Authority  Area1  Area2  Area3  Area4  Area5  Area6  Area7  Area8

### 4.4 Voice call settings

Four voice phones can be set, and one phone number can control 1-4 partitions. When an alarm occurs in the selected partition, the host will send information to the phone number of the partition. Enter "P" in the phone number and the dialing will pause for one second.

*\*Note: You need to turn on the phone/message function, enter the "Alert Settings" and check "Call Voice Call" and "Send SMS" for the phone/message function to take effect.*

**Redial times:** the number of voice calls in case of alarm. When the phone number 1 is not answered, the phone number 2 will be dialed. The default is redial 5 times.

**Ringng times:** dial the telephone number on the host, and the ringng times of

the host automatically off hook (default 15 times).

After setting, click “Save Settings” .

Voice Call Settings

Basic parameters

Number of redials:  (1-15)

Ring times:  (0-15), set 0 to turn off the phone automatically off hook

telephone number

No.1	<input type="text"/>	Phone <input checked="" type="checkbox"/>	SMS <input checked="" type="checkbox"/>	Associated area <input checked="" type="checkbox"/>	Area1 <input type="checkbox"/>	Area2 <input type="checkbox"/>	Area3 <input type="checkbox"/>	Area4 <input type="checkbox"/>	Area5 <input type="checkbox"/>	Area6 <input type="checkbox"/>	Area7 <input type="checkbox"/>	Area8 <input type="checkbox"/>
No.2	<input type="text"/>	Phone <input checked="" type="checkbox"/>	SMS <input checked="" type="checkbox"/>	Associated area <input checked="" type="checkbox"/>	Area1 <input type="checkbox"/>	Area2 <input type="checkbox"/>	Area3 <input type="checkbox"/>	Area4 <input type="checkbox"/>	Area5 <input type="checkbox"/>	Area6 <input type="checkbox"/>	Area7 <input type="checkbox"/>	Area8 <input type="checkbox"/>
No.3	<input type="text"/>	Phone <input checked="" type="checkbox"/>	SMS <input checked="" type="checkbox"/>	Associated area <input checked="" type="checkbox"/>	Area1 <input type="checkbox"/>	Area2 <input type="checkbox"/>	Area3 <input type="checkbox"/>	Area4 <input type="checkbox"/>	Area5 <input type="checkbox"/>	Area6 <input type="checkbox"/>	Area7 <input type="checkbox"/>	Area8 <input type="checkbox"/>
No.4	<input type="text"/>	Phone <input checked="" type="checkbox"/>	SMS <input checked="" type="checkbox"/>	Associated area <input checked="" type="checkbox"/>	Area1 <input type="checkbox"/>	Area2 <input type="checkbox"/>	Area3 <input type="checkbox"/>	Area4 <input type="checkbox"/>	Area5 <input type="checkbox"/>	Area6 <input type="checkbox"/>	Area7 <input type="checkbox"/>	Area8 <input type="checkbox"/>
No.5	<input type="text"/>	Phone <input checked="" type="checkbox"/>	SMS <input checked="" type="checkbox"/>	Associated area <input checked="" type="checkbox"/>	Area1 <input type="checkbox"/>	Area2 <input type="checkbox"/>	Area3 <input type="checkbox"/>	Area4 <input type="checkbox"/>	Area5 <input type="checkbox"/>	Area6 <input type="checkbox"/>	Area7 <input type="checkbox"/>	Area8 <input type="checkbox"/>
No.6	<input type="text"/>	Phone <input checked="" type="checkbox"/>	SMS <input checked="" type="checkbox"/>	Associated area <input checked="" type="checkbox"/>	Area1 <input type="checkbox"/>	Area2 <input type="checkbox"/>	Area3 <input type="checkbox"/>	Area4 <input type="checkbox"/>	Area5 <input type="checkbox"/>	Area6 <input type="checkbox"/>	Area7 <input type="checkbox"/>	Area8 <input type="checkbox"/>
No.7	<input type="text"/>	Phone <input checked="" type="checkbox"/>	SMS <input checked="" type="checkbox"/>	Associated area <input checked="" type="checkbox"/>	Area1 <input type="checkbox"/>	Area2 <input type="checkbox"/>	Area3 <input type="checkbox"/>	Area4 <input type="checkbox"/>	Area5 <input type="checkbox"/>	Area6 <input type="checkbox"/>	Area7 <input type="checkbox"/>	Area8 <input type="checkbox"/>
No.8	<input type="text"/>	Phone <input checked="" type="checkbox"/>	SMS <input checked="" type="checkbox"/>	Associated area <input checked="" type="checkbox"/>	Area1 <input type="checkbox"/>	Area2 <input type="checkbox"/>	Area3 <input type="checkbox"/>	Area4 <input type="checkbox"/>	Area5 <input type="checkbox"/>	Area6 <input type="checkbox"/>	Area7 <input type="checkbox"/>	Area8 <input type="checkbox"/>
No.9	<input type="text"/>	Phone <input checked="" type="checkbox"/>	SMS <input checked="" type="checkbox"/>	Associated area <input checked="" type="checkbox"/>	Area1 <input type="checkbox"/>	Area2 <input type="checkbox"/>	Area3 <input type="checkbox"/>	Area4 <input type="checkbox"/>	Area5 <input type="checkbox"/>	Area6 <input type="checkbox"/>	Area7 <input type="checkbox"/>	Area8 <input type="checkbox"/>
No.10	<input type="text"/>	Phone <input checked="" type="checkbox"/>	SMS <input checked="" type="checkbox"/>	Associated area <input checked="" type="checkbox"/>	Area1 <input type="checkbox"/>	Area2 <input type="checkbox"/>	Area3 <input type="checkbox"/>	Area4 <input type="checkbox"/>	Area5 <input type="checkbox"/>	Area6 <input type="checkbox"/>	Area7 <input type="checkbox"/>	Area8 <input type="checkbox"/>
No.11	<input type="text"/>	Phone <input checked="" type="checkbox"/>	SMS <input checked="" type="checkbox"/>	Associated area <input checked="" type="checkbox"/>	Area1 <input type="checkbox"/>	Area2 <input type="checkbox"/>	Area3 <input type="checkbox"/>	Area4 <input type="checkbox"/>	Area5 <input type="checkbox"/>	Area6 <input type="checkbox"/>	Area7 <input type="checkbox"/>	Area8 <input type="checkbox"/>
No.12	<input type="text"/>	Phone <input checked="" type="checkbox"/>	SMS <input checked="" type="checkbox"/>	Associated area <input checked="" type="checkbox"/>	Area1 <input type="checkbox"/>	Area2 <input type="checkbox"/>	Area3 <input type="checkbox"/>	Area4 <input type="checkbox"/>	Area5 <input type="checkbox"/>	Area6 <input type="checkbox"/>	Area7 <input type="checkbox"/>	Area8 <input type="checkbox"/>
No.13	<input type="text"/>	Phone <input checked="" type="checkbox"/>	SMS <input checked="" type="checkbox"/>	Associated area <input checked="" type="checkbox"/>	Area1 <input type="checkbox"/>	Area2 <input type="checkbox"/>	Area3 <input type="checkbox"/>	Area4 <input type="checkbox"/>	Area5 <input type="checkbox"/>	Area6 <input type="checkbox"/>	Area7 <input type="checkbox"/>	Area8 <input type="checkbox"/>
No.14	<input type="text"/>	Phone <input checked="" type="checkbox"/>	SMS <input checked="" type="checkbox"/>	Associated area <input checked="" type="checkbox"/>	Area1 <input type="checkbox"/>	Area2 <input type="checkbox"/>	Area3 <input type="checkbox"/>	Area4 <input type="checkbox"/>	Area5 <input type="checkbox"/>	Area6 <input type="checkbox"/>	Area7 <input type="checkbox"/>	Area8 <input type="checkbox"/>
No.15	<input type="text"/>	Phone <input checked="" type="checkbox"/>	SMS <input checked="" type="checkbox"/>	Associated area <input checked="" type="checkbox"/>	Area1 <input type="checkbox"/>	Area2 <input type="checkbox"/>	Area3 <input type="checkbox"/>	Area4 <input type="checkbox"/>	Area5 <input type="checkbox"/>	Area6 <input type="checkbox"/>	Area7 <input type="checkbox"/>	Area8 <input type="checkbox"/>
No.16	<input type="text"/>	Phone <input checked="" type="checkbox"/>	SMS <input checked="" type="checkbox"/>	Associated area <input checked="" type="checkbox"/>	Area1 <input type="checkbox"/>	Area2 <input type="checkbox"/>	Area3 <input type="checkbox"/>	Area4 <input type="checkbox"/>	Area5 <input type="checkbox"/>	Area6 <input type="checkbox"/>	Area7 <input type="checkbox"/>	Area8 <input type="checkbox"/>



## 4.5 Timing Arm/Disarm

User can set a fixed time to arm/disarm the partition, 00:00 is invalid time, there are four groups of timing arm/disarm time in total.

**Timed Arm / Disarm**

Timing arm and disarm 1

time:

Repeat cycle:  Sunday  Monday  Tuesday  Wednesday  Thursday  Friday  Saturday

operating:

Associated area:  Area1  Area2  Area3  Area4  Area5  Area6  Area7  Area8

Timing arm and disarm 2

time:

Repeat cycle:  Sunday  Monday  Tuesday  Wednesday  Thursday  Friday  Saturday

operating:

Associated area:  Area1  Area2  Area3  Area4  Area5  Area6  Area7  Area8

Timing arm and disarm 3

time:

Repeat cycle:  Sunday  Monday  Tuesday  Wednesday  Thursday  Friday  Saturday

operating:

Associated area:  Area1  Area2  Area3  Area4  Area5  Area6  Area7  Area8

Timing arm and disarm 4

time:

Repeat cycle:  Sunday  Monday  Tuesday  Wednesday  Thursday  Friday  Saturday

operating:

Associated area:  Area1  Area2  Area3  Area4  Area5  Area6  Area7  Area8

## 5. System maintenance

### 5.1 System information

Display the host web page, voice, hardware and firmware version number.

Users can also use the mobile app to scan the QR code to add a host, please refer to "III. APP Use".

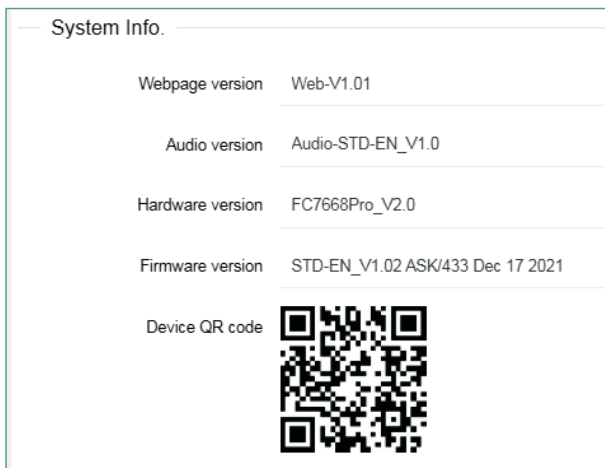

### 5.2 Time settings

**Set time automatically:** when it is turned on, it will automatically check the time with the timing server;

**Automatic adjust to summer time:** from 2:00 a.m. (Beijing time) on the first Sunday in the middle of April, set the clock one hour earlier, that is, to set the clock from 2:00 a.m. to 3:00 a.m. on the first Sunday in the middle of September, set the clock one hour earlier, that is, to set the clock from 2:00 a.m. to 1:00 a.m., and the daylight saving time ends. Automatic adjustment of daylight saving time is off by default.

**Time server:** the address of the server represents different time measurement standards.

**Server port:** the port corresponding to the time server.

**Time update interval:** 24 hours by default.

**Time zone:** click the drop-down menu to select. (Factory default: GMT+8:00)

You can modify the time manually at the current time. If "synchronize with computer time" is enabled, the manual setting is invalid. After setting, click "Save Settings".

### Date And Time Settings

Set time automatically  ON

Automatic adjust to summer time  OFF

Time server

Server port

Time update interval  0 means update only once, unit is hour

Time zone

Current time   Synchronize with computer time

### 5.3 System restart

Click the "Restart now" button, then pop up "Do you really want to restart?", Click "OK" to restart.

### System Restart

### 5.4 System backup

If you want to set the parameters of multiple hosts to the same configuration, you can export the set device parameters, and then import the exported files to other hosts to be set. Click "backup configuration file", the bottom of the screen prompts that the "bin" file has been downloaded.

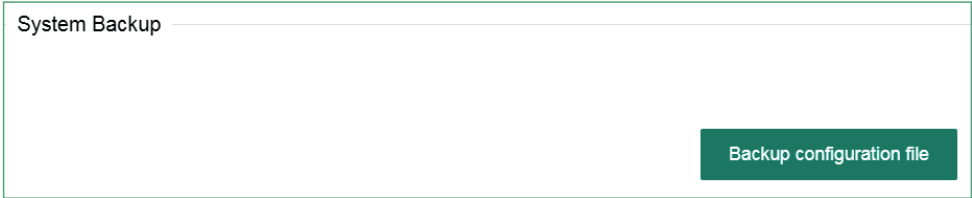

### 5.5 System restore

Restore all the configuration of the host, click "load configuration file" and lead in the "Config.bin" file - "Restore.". The progress of restoration is displayed below the button. Please do not perform other operations during restoration.

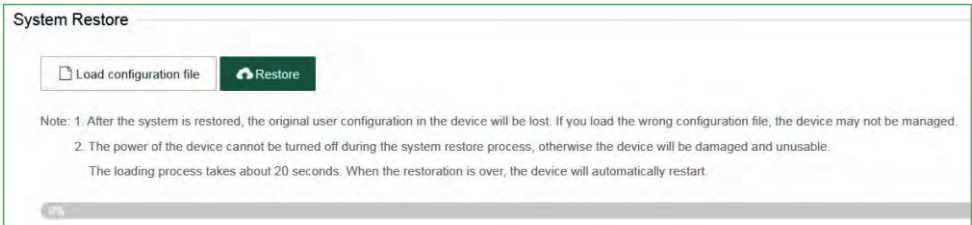

## 5.6 System upgrade

The web program file is “ Web.bin ”, the voice program file is “ Audio.bin ”, the firmware program file is “ FC7668Pro.hex ” File, in the process of upgrading, there will be a green bar and percentage process display at the bottom of the page, please do not turn off the page and turn off the power in the process of upgrading. Restart the device after upgrading.

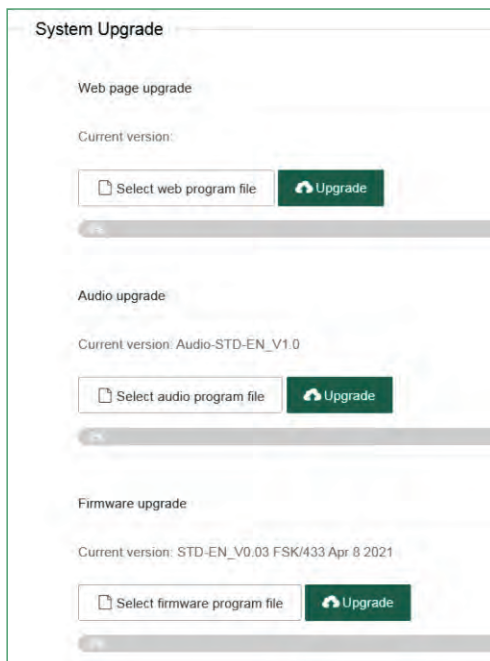

**System Upgrade**

Web page upgrade

Current version:

Select web program file Upgrade

Audio upgrade

Current version: Audio-STD-EN\_V1.0

Select audio program file Upgrade

Firmware upgrade

Current version: STD-EN\_V0.03 FSK/433 Apr 8 2021

Select firmware program file Upgrade

## 5.7 Reset device

Restore the host to the factory preset settings, click "Reset" and enter the administrator password - "OK" in the pop-up menu. The host will automatically restart and take effect.

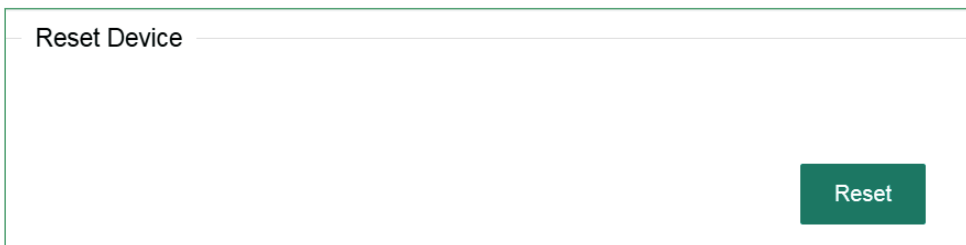

**Reset Device**

Reset

### III. App use

#### 3.1 APP download and registration

Please scan the following QR code to download the installation package and register an account.



#### 3.2 Account registration

Click to enter the APP login interface, new users please click "register", according to the prompt to complete the registration.

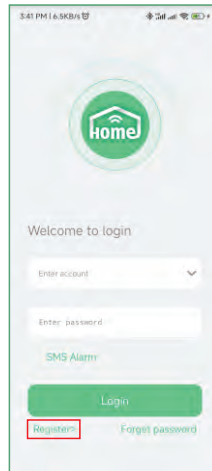



### 3. Add panel

After logging in the account, as shown in Fig 3.1, select "+" at the upper right, scan the QR code on the sticker on the device body or on the webpage.

You can find the added host on the homepage.

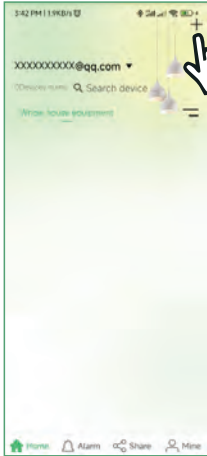

Fig 3.1



Fig 3.2

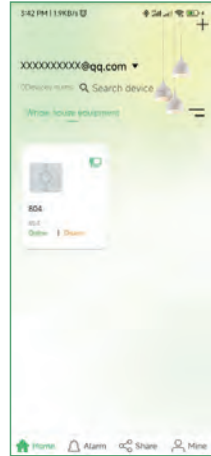

Fig 3.3

## Technical specifications

**External AC power supply voltage:** input 110 ~ 240VAC, output 15V DC / 3A

**Host built-in rechargeable battery (optional):** 12V / 7Ah

**Low battery voltage:**  $\leq 11V$

**Backup battery duration:** about 24 hours (when only one keyboard is connected)

**Alarm dialing mode:** internet alarm, telephone alarm and GSM alarm

**DTMF dial frequency deviation:**  $< 1.5\%$

**Communication protocol of central monitoring server:** ADMCO Contact ID, SIA-2013, Meian Proprietary Agreement

**Modulation mode:** ASK / FSK (optional)

**Wireless receiving and transmitting frequency:** 433MHz / 868MHz (optional)

**Recording time:** 15 seconds

**Wireless receiving range:** 100-150m (open space)

**Working temperature range:** 0°C to 45°C (32°F to 120°F)

**Storage temperature range:** - 20°C to 60°C (- 4°F to 140°F)

**Humidity:** 85% relative humidity at 30°C (86°F)

## System maintenance

### PERIODIC TESTING

The design idea of safety system is to let you maintain as little as possible. However, in order to ensure the reliability of the system, we still need to carry out "walking test" at least once in three months. If there is any problem, please consult the technician immediately.

### CLEAN THE MAIN HOST

After using for a period of time, the host may be stained with oil or dust. Please clean with soft cotton cloth or sponge and wipe dry.

**Note:** please do not use any friction agent or organic solvent, such as kerosene, acetone, strong glue, etc. to wipe the case, so as not to damage the external appearance of the body.

## Product function limitation

Although the alarm device you purchased is highly safe, it is still not 100% safe. No matter how advanced the alarm system is, there will be false alarm or failure. The reasons may be as follows:

**Lack of maintenance:** if the system is used for a long time, but maintenance and testing are not carried out immediately, the sensitivity of the detector may be reduced and false alarm or missing alarm may occur; the siren may also lose its function and cannot sound.

**Power failure:** if the AC power supply is cut off for a long time, and the backup battery is insufficient, the system will not continue to work normally, so that the protection area can not alarm accordingly even if there is an alarm.

**Limitations of smoke detector:** sometimes, because the alarm occurs on different floors of the house or is too far away from the detector, the smoke detector fails to receive a strong enough smoke signal, which will cause missed alarm.

**The system fails to receive the alarm information:** if the intruder uses the unprotected skylight and some unexpected entrances to enter, or the intruder has the relevant professional knowledge and knows how to find the method to make the alarm equipment fail, the alarm equipment will not report the alarm immediately.

In order to ensure the normal operation of the detector and the whole alarm system, it is recommended that users often carry out periodical testing. Even if the alarm system is installed for protection, users should also be cautious about the safety of their lives and property. We will continue to devote ourselves to the development of new security products. Please keep in touch with us so as to obtain our latest technical products and relevant information. Your support is the driving force of our work! If our series of products are updated, we will publish them on our website. Please visit our website to get the latest information.



